

MANITOU SPARE PARTS GUIDE



Handling your world

The Manitou Group was founded by the Braud family more than 60 years ago. Today, Manitou Group is the world leader in all-terrain material handling. It designs, manufactures, distributes and services equipment for construction, agriculture and many other industries.

The Group's product ranges include all-terrain fixed, rotating and heavy-load telehandlers; all-terrain, semi-industrial and industrial masted forklift trucks; wheel or track skid-steer loaders; access platforms; truck-mounted forklifts; warehousing equipment; and attachments.

Through its iconic brands – Manitou, Gehl and Mustang – distributed by a network of 1,400 dealers, the Group offers the best solutions to create optimum value for its customers.

Headquartered in France, the group registered in 2015 a revenue of 1.287 billion Euros in 140 countries and employs 3,214 people all committed to satisfying customers.



1958

Marcel Braud conceives the idea of the Manitou truck.

1972

Group enters foreign markets.

Sales partnership agreement signed with Toyota for exclusive distribution of Toyota industrial forklift trucks in France.

1981

Launch of first Manitou telehandler.

1984

Manitou floated on stock exchange.

1993

First MRT rotating telehandlers are sold.

1995

Launch of first range of access platforms.

1996

ISO 9001 certification obtained.

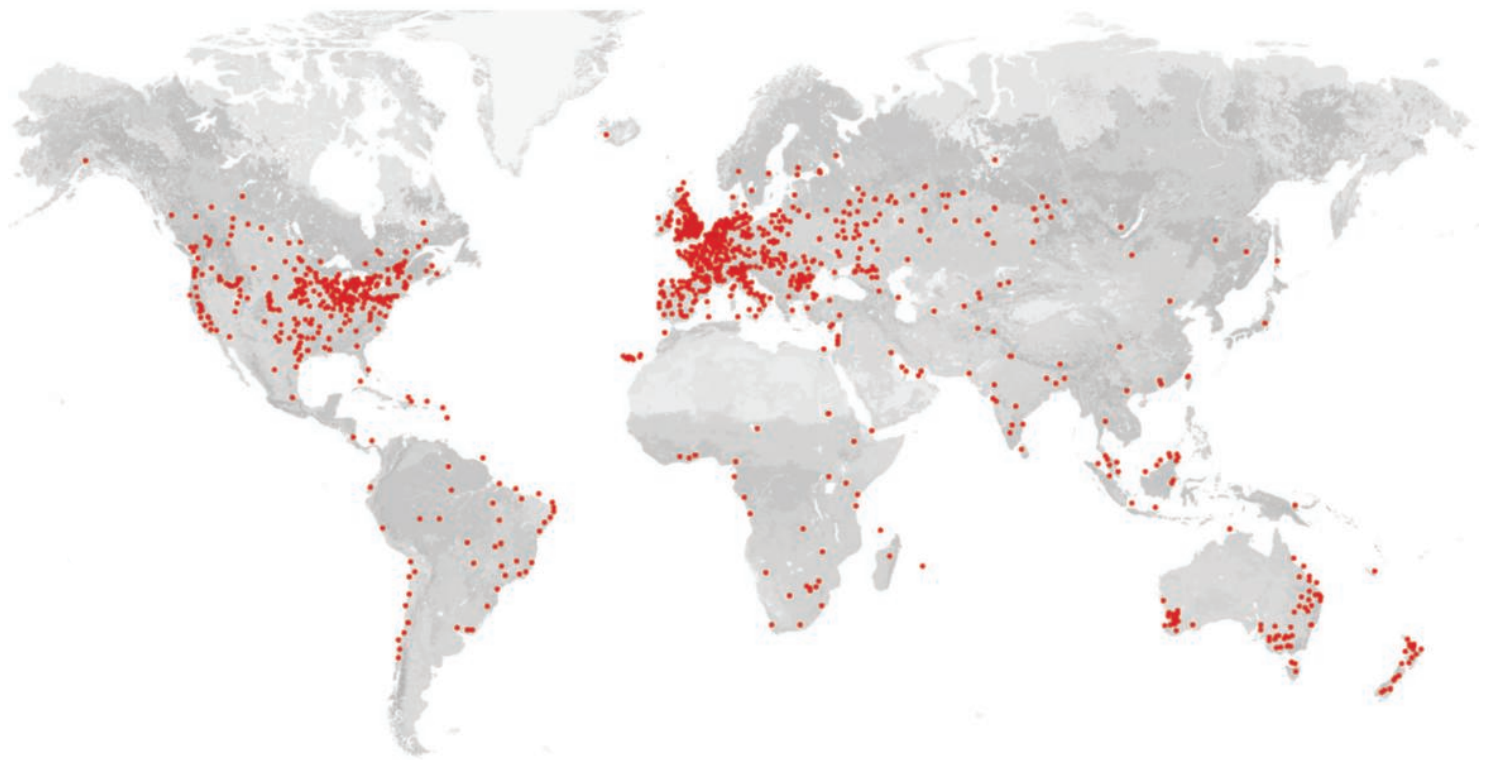

3 brands
distributed through
1,400 dealerships
in 140 countries

- 21 subsidiaries
- 9 production sites
- 3,214 employees worldwide
- 64% of the share capital held by the founding families
- 78% of revenue comes from foreign markets
- 1.287 billion Euros revenue in 2015



2006

Manitou hits the 1 billion euros sales milestone.

2007

Opening of an international logistics center spanning 22,000 m².

2008

Takeover of the American company Gehl.

2010

Launch of Gehl and Mustang articulated loaders.

2013

Consolidation of Yanmar partnership as Yanmar becomes a Group shareholder, with 6.26% of the capital.

2015

Manitou sells its 500,000th machine worldwide.



The 5 Manitou Brands



Access platforms

Scissor lifts, vertical or telescopic, platforms for personnel lifting, diesel or electric.



Telescopic handlers

Load offset trucks, all-terrain, rotating, and high tonnage. Load capacity 2 t to 35 t. Up to 32 m height.

Manitou's product range

Construction, agriculture, industrial: MANITOU offers a comprehensive range of handling machinery and powered access platforms, specifically adapted to the need of your sector. With customers feedback, **MANITOU** is **constantly adapting** its product in order to meet your needs in line with developments in the marketplace. **MANITOU** allows you to easily find product solutions to meetl your requirements (type of activity, level of use, budget, etc.) rapidly and reliably.





Counterbalanced forklifts

Industrial, semi-industrial and all-terrain. Capacity 1.5 t to 10 t.



Warehouse equipment

Manual or electric forklifts, pallet trucks, tow tractors, and order pickers for all your handling needs.



Truck-mounted telescopic

Designed to directly mount onto the rear of a trailer for the unloading of materials up to a maximum of 2.7 t loading capacity, with a lifting height in excess of 1.5 m.





200E

200E

200F



SUMMARY
Manitou
Spare Parts Guide

Services & Solutions

8

- Reduce
- Financing service
- Maintenance service contract
- Warranty service contract
- Manitou dealer network
- Manitou genuine parts
- Manitou standard exchange
- Fleet management & geolocalisation
- Used
- Logistical power

Servicing & Maintenance

22

- Oils
- Greases & greasing attachment
- Filters & belts
- Liquid coolants
- Servicing, paint & cleaning

Tyres, chains & hydraulic components

52

- Pneumatic tyres
- Industrial tyres
- Lifting chains
- Hydraulic and wear parts

Signal, visibility & electrical accessories

64

- Batteries
- Electrical components
- Switches & Key switches
- Rear lights
- Front lights
- Working lights
- Beacons
- Lights & Horns
- Lamps & Bulb

Comfort, cabin & safety

82

- Driver seats, seats & seatbelts
- Sound system
- Driving comfort
- Geolocalization & anti-theft protection
- Safety
- Peripherals components
- Wiper blades
- Rear-view mirror

Machine attachment & handling equipment

100

- Rehandling and loading equipment
- Handling suspended loads
- Personnel lifting equipment
- Additional equipment
- Warehousing equipment

Shop

124

- Scale models
- Toys
- Office accessories
- Promotional items
- Clothes

Always attentive to customer needs, Manitou has developed a full range of complementary services, which can be adapted to your needs, so that you can get the most out of your machine.

To fulfill your requirements rapidly, our global expertise is delegated to a local level, through the Manitou network, to ensure that wherever our customers are in the world, we are there to provide them with the best solution.

Discover for yourself the many services offered by the Manitou network, which allow you to work with peace of mind.



- Dealership network
- Maintenance Contracts
- Financing
- Warranty extensions
- Connected machine / fleet management
- Second-hand
- Genuine spare parts





SERVICES & SOLUTIONS

Reduce	10
Financing service	12
Maintenance service contract	13
Warranty service contract	14
Manitou dealer network	15
Manitou genuine parts	16
Manitou standard exchange	17
Connected machines / Fleet management	18
Used	19
Logistical power	20

REDUCE

The Manitou Group's vision

The REDUCE approach aims to improve the quality of working life for users of our machines and improve productivity. This calls for transparency of consumption data (Fuel Eco-Program), reduced emissions, raised awareness of the total cost of ownership (TCO), and greater emphasis on the health and safety of users.



REDUCE TCO PROGRAM

REDUCE TCO (Total Cost of Ownership) provides you with detailed information on the breakdown of item costs and helps you to optimize the profitability of your production tool.

The TCO is the total cost of ownership of an asset. This indicator is based not only on fixed costs, but also on all the variable costs.

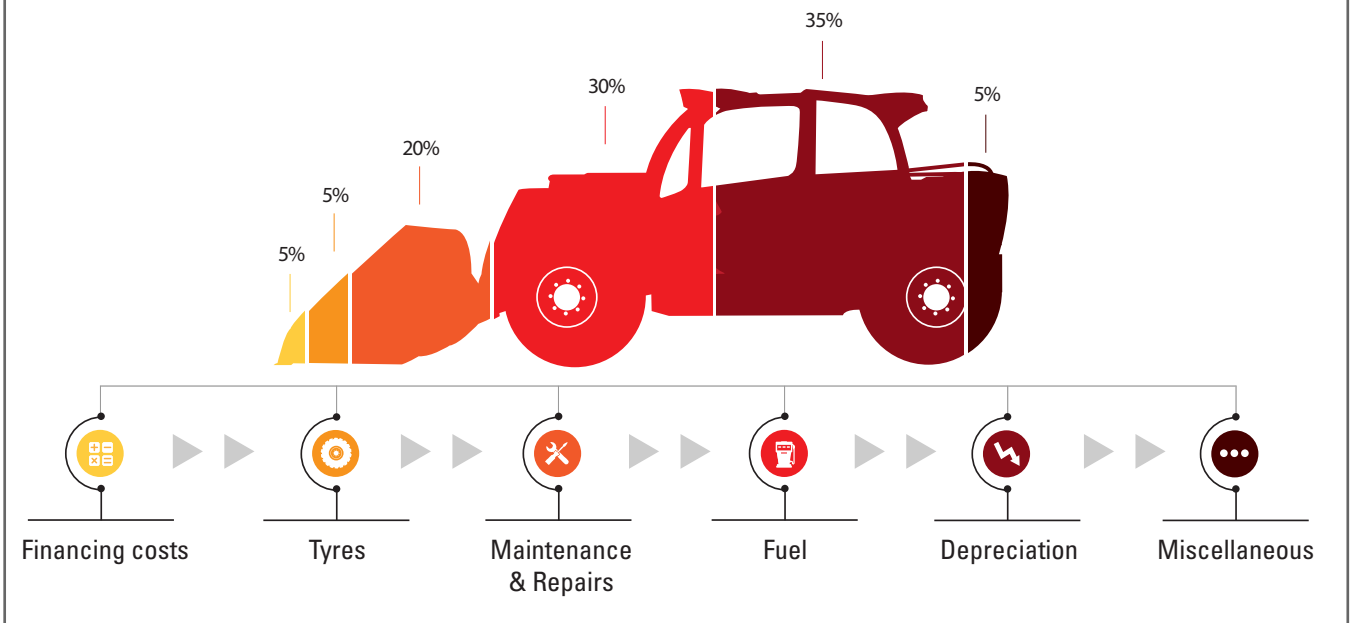

Discover our online calculator at tco.manitou.com. Tailor your cycle to your activity and equipment. View the major items of expenditure on a graph.



tco.manitou.com

receive your personalized report by email





REDUCE FUEL ECO-PROGRAM

The REDUCE Fuel eco-program has implemented a transparent internal protocol to relay the fuel consumption measurements of our machines.

Fuel consumption alone accounts for more than **30% of the total cost of your machine.** With this in mind, Manitou Group has developed its REDUCE Fuel Eco-Program

View our online calculator to personalize your cycle and estimate your consumption, CO2 emissions and the financial gain achieved.



reduce.manitou.com

We have implemented an eco-driving module to train our network and users to reduce their fuel consumption.



Machine charts

We indicate the fuel consumption of our machines for the two activities representative of the machine, and the associated CO2 emissions.



REDUCE application

25 simple tips

Our recommendations for use will guide you in reducing your fuel consumption and your carbon footprint.

Eco-driver simulator

Eco-driving course

To raise your awareness of fuel costs and CO2 emissions, Manitou Group has created an eco-driving simulator.



MANITOU FINANCE

MANITOU financing solutions make it easier for you to buy your new or second-hand MANITOU!



Speak to your dealer, who is ideally placed to offer you simple financing solutions that are tailored to your needs: choice of payment date, repayment frequency options, financing methods according to your activity.

All In offer

It's a full service offer (machine + services + maintenance). You know your TCO (Total Cost of Ownership).

- Spreads the maintenance cost over the contract duration
- Benefits from a well maintained machine
- Simplified administrative tasks
- Off-balance solution*.

Financial lease

Rental solution with a purchase option. You can modulate your payments and choose your terms.

Your rent is less expensive compared to a patrimonial approach.

At the end of the contract, you can purchase the machine at the determined residual value.

Benefits from an off-balance solution*

Operating Lease

You lease a machine for a cost of use known. Possibility to add maintenance services. No need to worry about resale of the equipment. Benefits from an off-balance solution*

Loan

You have the ownership of the machine. You benefit from a seasonal financing plan. Simple financial offers (without VAT).



*In accordance with the standards accepted under tax rules- Subject to customer's auditors.

Advice

Your MANITOU dealer can offer you several financing solutions



With Manitou maintenance contracts, the long-term performance of your machine is maintained, in the most cost-effective way.

Maintenance quality is crucial to the long-term performance of your equipment.

For that reason, Manitou has developed three maintenance contracts, with different options, to meet customer needs in the best possible way.

Performance and peace of mind

When you take out a Manitou maintenance contract, you can concentrate on your business and organize your activities with complete peace of mind.

- Equipment is in optimal working condition at all times.
- Technicians specifically trained in Manitou technologies.
- Guaranteed use of original Manitou parts.
- Reduce repair costs with regular monitoring of your machine / avoid costly interventions.
- Maximise resale value of your equipment on the second hand market.

Simple, transparent management

- Simple, tailored schemes.
- Control your budget.

Advice

To find the contract that suits you best, contact your dealer.



Because unexpected things will always happen,
Manitou warranty extensions are there to protect you.
With Maniplus, you can work with peace of mind!



When you buy your Manitou, you have the benefit of a one-year manufacturer's warranty.

With Maniplus warranty extensions, you can prolong this warranty, which covers repairs arising from faulty parts and / or mechanical defects.

Rigorous management

No machine, no matter how solid, is not immune from breakdown. Everybody wants to minimize the risks. The Maniplus warranty extension gives you total peace of mind. You are protected from all major repairs, allowing you to avoid potentially costly hazards.

It is important to protect yourself from malfunctions, which could affect the main components of your machine.

A tailor-made warranty

With Maniplus, you have the benefit of rates with no hidden surprises, tailored to your needs, activity and work environment.

Protect your Manitou up to 5 years according the coverage you needs!

- ESSENTIAL Cover: Covers the powertrain*
- TOTAL COVER :Includes all components of the machine*

*Offer details available from your dealer.

Advice

To find the contract that suits you best, contact your dealer.

Manitou dealer network

A network of nearly 1,400 dealerships at your service



Expertise of Manitou's Professionals

Undergoing regular training in our Training Centres, MANITOU technicians provide the expertise of a network of professionals.

Manitou's Professionals are committed to:

- Giving you the warmest of welcomes and to make you an offer tailored to your needs, with a wide range of parts and services.
- Carry out the servicing or maintenance operation within the agreed time frame, to minimize downtime of your equipment.
- Carry out systematic checks during this operation on the proper functioning of the main security features of your Manitou.
- Provide you with full details of the operation to be carried out, the parts to be replaced and the labour time.
- Provide you with replacement equipment at preferential rates in the event of prolonged immobilization of your equipment.
- Respect operational procedures and their compliance with the service order.

Manitou Genuine Parts

Systemic fitting of genuine Manitou spare parts ensures total security for the durability of your Manitou machine.



Manitou distributes original spare parts. When you order spare parts via your Manitou dealership, you can be confident that you are getting parts manufactured in full compliance with the original standards.

Using spare parts or attachments that comply with the manufacturer's specifications ensures mutual compatibility of parts in the framework of the required use of your equipment.

Manitou expertise

When you entrust the maintenance of your machine to your dealership, your parts will be installed by Manitou-trained technicians. They have direct access to our technical support, on-line documentation and Manitou diagnostic tools.

Their working time is optimized, and they are always informed of the latest updates, enabling them to offer you a customized, efficient customer service.

Safety &
Quality

Performance and durability

Original Manitou parts are specially designed to fulfill Manitou's strict specifications. They meet the design objectives of your equipment linked with the possible conditions of use, from normal to more intensive.

Choosing the original Manitou part means preserving the longterm performance of your machine and extending its useful life. That allows you to keep your machine operating for as long as possible and to optimize your productivity time.

Manitou Standard Exchange Parts

Manitou spare parts at the right price.



Through its «standard exchange» program, MANITOU offers renovated parts with the same specifications as new ones. MANITOU standard exchange parts follow an industrial process, which complies with the manufacturer's strict standards.

Offer available following each country, contact your dealer for more information.

MANITOU renovated parts

Renovation begins with strict quality control of the part on receipt, followed by a process consisting of:

- cleaning,
- refurbishment of components,
- replacement of defective parts with genuine new parts,
- reassembly in accordance with standard practice,
- a comprehensive test,
- validating the performance and correct functioning of the part.

MANITOU Standard Replacement offers a continually expanding range of parts:

- Particle Filters
- Engines
- Right-angle drives
- Gearboxes
- Torque converters
- Hydrostatic pumps and motors
- Injection pumps
- Printed circuits MRT radio controls

Quality
warrantied

«Standard exchange» program

The aim of the MANITOU standard exchange range is to allow mechanical repairs to be carried out at the lowest cost.

All reconditioned parts are refurbished to the standard of the original MANITOU part. All upgrades, modifications and improvements are carried out during reconditioning. You are assured of a part that is comparable in quality to a new part.

You benefit from:

- A product renovated to «as new» condition
- A reliable product at a lower cost
- Technical support Manufacturer quality
- Manufacturer's warranty

The energy and raw materials used are less than with new parts. You are acting responsibly and protecting the environment by using parts with a low environmental impact.



Looking for a solution to manage,
optimize and geolocalise your equipment?

Easy Manager is a simple and flexible tool that optimizes operational
monitoring of your machines, whatever your field of business.



Powerful technology

- GSM / GPS Module fitted in the equipment
- Emits a signal, whether your machine is operating or not
- Forwards information directly to your account
- Platform accessible 24/7
- Internet & mobile application

Optimum security and maintenance

- **Protect yourself against fraudulent use.**
Using alerts programmed hourly or by zone, you can ensure that your machines operate only where and when you want.
- **Manage your maintenance effectively.**
Easy Manager manages your maintenance schedule and informs you by email of any maintenance to be carried out. This guarantees a machine that is in perfect working order.
- **Monitor your machines remotely.**
Easy Manager allows you to remotely view the status of your machines instantly, regardless of their location.
- **Monitor the status of your machines.**
Utilization reports give you detailed information on the way your equipment is used. Having a clear picture of the state of your equipment makes it easier for you to replace your machines.
- **Ensure the resale value of your equipment**
with machines that are used correctly and properly maintained.
- **A consistently well-controlled budget.**
Save on your operational and logistical costs.

Advice

To find the contract that suits you best, talk to your dealer.

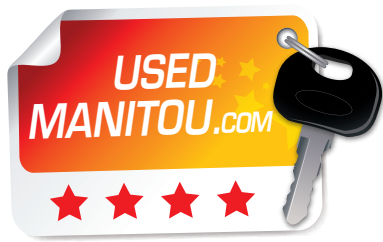

Are you looking for good second hand handling equipment?
We will help you find the right equipment!
Go to www.usedmanitou.com, the MANITOU network website.

The screenshot shows the top navigation bar with 'Manitou Group' on the left and 'Système Métrique' and 'Français' on the right. The main header features the 'MANITOU Occasion' logo and navigation links for 'Recherche', 'Références', and 'Concessionnaires'. Below the header is a search section with the text 'Trouvez une occasion parmi nos 867 annonces...'. It includes two dropdown menus: 'Sélectionnez une Catégorie' and 'Sélectionnez un Pays', followed by a red 'Recherche' button. Below this is a world map with red dots indicating locations, with the text '... dans l'une des 147 concessions dans plus de 14 pays.' and a red 'Voir la carte' button.

A wide range

You have access to a wide range of equipment selected by the dealerships. You have the guaranteed quality and professionalism of the manufacturer's website.

No surprises about the state of your equipment; your dealer will keep you informed: your equipment is subjected to a thorough visual inspection of all its components to provide you with all the essential elements for making your decision, and to give you the option of reconditioning, depending on your needs.

For all your needs

Whatever your need or budget, we have the machine you need!

Advice

To find the right second-hand machine for you, go to the used.manitou.com website

Availability & Quick Delivery

A logistics center for genuine Manitou spare parts
in more than 120 countries worldwide.



To provide the best service at all times, Manitou has opened a 33,000 m² international spare parts logistics center for its dealerships (27,000 m² covered and 6,000 m² outside storage). The aim is to supply you rapidly with all the spare parts required for the maintenance of your MANITOU throughout its service life, throughout the world.

Our eight worldwide distribution centers (in France, Italy, USA, South Africa, Australia, Russia, Brazil, and Singapore) respond rapidly to your needs with more than 60,000 available items. Orders are delivered within 24 hours in Europe and within 72 hours in other countries.



Manitou guarantees a spare parts service for more than 220,000 items for up to 10 years from the time your machine was introduced on the market.

Our dealership network consists of 1,400 points of sale, with spare parts for current machines always kept well stocked. Our dealers will help you decide which part to order, and advise on how to install it.

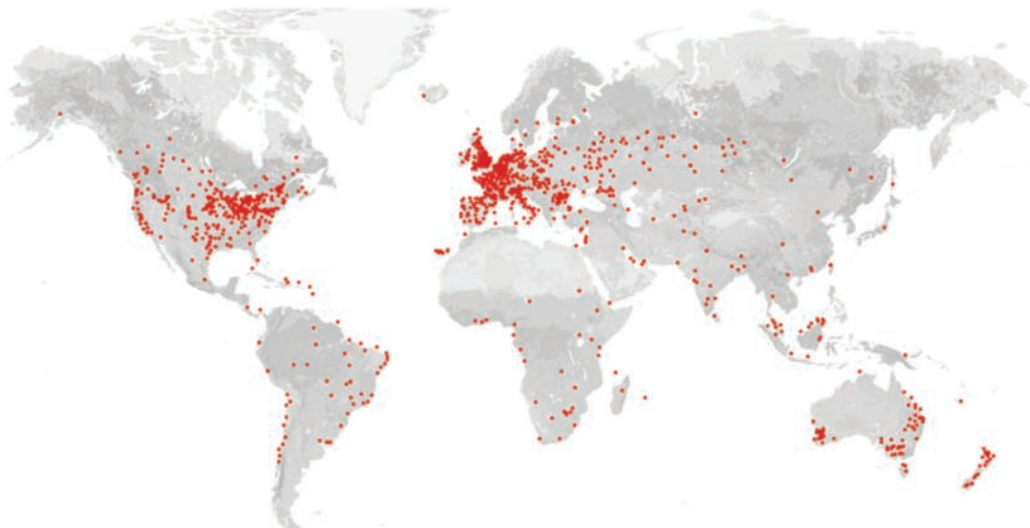





**Huile
MANITOU EVOLGY**

High technology motor oil for heavy duty engine
Huile moteur de haute technologie pour moteurs diesel professionnels
Olio motore ad alta tecnologia per motori diesel professionali
Aceite de motor de alta tecnologia para motores diesel profesionales
...sche diesel motorolie

MANITOU

299888



5L

SERVICING & MAINTENANCE



Engine oil	24
Hydraulic & Transmission Oil	26
Axle Oil	30
Greases & Lubricants	32
Greasing & Lubricant attachments	35
Filters	38
Liquid Coolants & Starting Aid	43
Mechanical Maintenance	44
Bodywork Maintenance	45
Painting	48
Interior & Exterior Maintenance	50
Cleaning	51



Engine oil

Servicing & Maintenance

Manitou ENGINE OIL

Engine lubrication is an essential element for the smooth running and maintenance of your MANITOU, and requires great care. The variety of high quality lubricants allows you to ensure optimal performance, protection against abnormal or premature wear, cleaning of the circuit and reduction of environmental impact.

Engine oil

Oil is essential for the proper functioning and longevity of your MANITOU's engine. It fulfills several roles:

- Lubrication of surfaces: reducing friction between touching parts and ensuring maximum performance, thanks to the presence of a film of oil separating the two surfaces.
- Protection against corrosion: combating humidity, acidic substances and any other factors..., anti-corrosion additives prevent metal corrosion due to the combined action of water, oxygen and air of some oxides of combustion. They form a protective film or passivation of the protected surface.
- Engine cooling: maintaining thermal equilibrium in the engine by evacuating some of the heat produced by friction.
- Evacuation of particles: the detergent and dispersion performance allow better cleaning of the engine's interior. By keeping the impurities and combustion residues in suspension, it prevents soiling and build-up of particle deposits in the engine, allowing them to be caught in the filter.

Why should you change the oil in your engine regularly?

If your MANITOU's engine oil is not changed regularly, you run the risk of seeing its performance deteriorate. Poor lubrication of the engine inevitably leads to premature degradation. Indeed, the oil deteriorates because of the strong pressures and temperature variations. An oxidized oil loses the properties of its additives and components, accelerating pollution and deterioration of the engine. Frequency of oil changes: opt to have your engine serviced regularly to maintain its efficiency: your MANITOU machine's first oil change should be carried out after 50 hours of use, then every 500 hours, or within a maximum of one year. Indicative data may vary according to model type.

Advice

Always refer to the specific service manual for each piece of equipment. Consult your MANITOU dealer.



MANITOU EVOLOGY 10W40 Engine Oil

High performance, for modern 4-stroke diesel engines. Agricultural work, transport, or public works in harsh operating and load conditions. Specific to the technological development of low-emission engines.

- Complies with EURO IV and V standards.
- For engines with particle filter requiring a grade 10W40.
- For 3B engines.

Specifications: API CJ4

Drum	209 l	895840
Drum	55 l	895839

Can	20 l	895838
Can	5 l	895837



MANITOU PREMIUM 15W40 Engine Oil

For 4-stroke diesel engines installed in heavy duty vehicles, agricultural equipment and public works, complying with standard EURO III.

- Reduces oil change frequency.
- Engine oil type SHPD suitable for 3A engines.

Specifications: API CI4

Drum	209 l	895834
Drum	55 l	895833

Can	20 l	895832
Can	5 l	895831



MANITOU 500 15W40 engine oil

Specially formulated for the lubrication of MANITOU trucks' 4-stroke engines. Rigorously selected base oils and specific additives for agricultural and public works use. Formulated to reduce pollutant emissions.

- Improved engine cleanliness.
- Reduction of oil consumption, long-term savings.
- Protection of engine components, increased engine service life.

Specifications: API CH4

Drum	209 l	582359
Drum	55 l	582358

Can	20 l	582357
Can	5 l	661706



MANITOU SPECIAL INDUSTRY 15W40 Engine Oil

Specially formulated for 4-stroke gas and diesel industrial engines.

- Complies with industrial environmental standards.
- Very high level of detergency and dispersion.
- Keeps the engine clean, does not clog the filters.

Specifications: API CH4, SL

Drum	209 l	745153
------	-------	---------------

Can	20 l	744640
Can	5 l	744639

Advice

Possibility to purchase oil in bulk or maxi drum following references and countries. Contact your Manitou dealer. No time to carry out oil changes? Take out a Comfort Service contract: see chapter Services & Solutions.



Hydraulic & Transmission Oil

Servicing & Maintenance

Manitou HYDRAULIC AND TRANSMISSION OIL

Every time your MANITOU is used, the hydraulic system is put under stress. Regular complete oil changes of the system are therefore essential to ensure the good performance of your machine. For these operations, your dealer recommends that you use an original hydraulic oil and do not substitute an unsuitable oil, which might not match the hydraulic system of the machine and could cause serious damage.

Frequency of fluid changes

Your machine's fluid changes and their frequency are very important. They help to maintain consistency of performance and reduce wear resulting from particle contamination. Our design department has investigated the frequency specific to each machine to maintain the same level of performance while optimizing maintenance costs. Please refer to your machine's operating manual.

Why use a MANITOU hydraulic oil?

Specially formulated at the design stage of your MANITOU machine, this oil has characteristics that are specific to the hydraulic system of your equipment model. Its qualities provide the best performance, guarantees greater longevity of the hydraulic system, and improved working safety.

MANITOU hydraulic oil incorporates the latest technological advances.

- Excellent fluidity when cold.
- Excellent shear resistance.
- High thermal stability.
- Excellent anti-oxidation properties.
- Low pour point: -39°.

Using MANITOU spare parts, our own brand hydraulic filters, and observing the servicing frequency recommended by your dealer, will guarantee maximum protection of your machine's circuit.

Advice

Choosing MANITOU servicing is a long-term investment in your truck for optimal profitability and performance.



MANITOU Hydraulic Oil

Intended for use in the hydraulic system and hydrostatic transmission of your MANITOU forklift. Viscosity ISO 46.

- Outstanding fluidity when cold.
- Excellent shear resistance.
- High thermal stability.

Drum	209 l	546109
Drum	55 l	546108

Can	20 l	582297
Can	5 l	545500



MANITOU HYDRO BIO Hydraulic Oil

For your machine's tough operating conditions, where the environment may be threatened by leaks or loss of oil.

- Viscosity ISO 46.
- Minimizes the effects of pollution on the environment.
- For use at a wide range of temperatures and under high pressure.
- Good oxidation and hydrolytic stability.

Drum	209 l	947941
------	-------	---------------

Can	20 l	947942
-----	------	---------------



MANITOU SPECIAL INDUSTRY Hydraulic Oil

Intended for use in the hydraulic systems of all industrial forklifts.

- Viscosity ISO 32
- Outstanding fluidity when cold.
- Excellent filtering properties.
- High anti-wear and extreme-pressure performance.

Drum	209 l	744636
------	-------	---------------

Can	20 l	744637
-----	------	---------------

Can	5 l	744638
-----	-----	---------------



MANITOU DEXRON III Automatic Transmission Oil

High quality lubricant to ensure long-term protection of torque converter and automatic transmissions. Intended for DEXRON III G type manufacturer recommendations, and compatible with DEXRON II.

- Fluidity at lowest temperatures, for better gear shifting in the cold.
- Oxidation resistance superior to Dexron II standard.
- Oil film stability at high temperature.
- Anti-wear, anti-corrosion and anti-foam.

Drum	209 l	947975
------	-------	---------------

Can	20 l	947973
-----	------	---------------

Drum	55 l	947974
------	------	---------------

Can	5 l	947972
-----	-----	---------------

Can	1 l	958186
-----	-----	---------------

Advice

For optimum reliability, the hydraulic tank breather should be changed at the same time as the tank is drained, see p.64.



MANITOU Mechanical Transmission Oil

Recommended for the lubrication and protection of the angle gears, gearboxes and transfer boxes. Viscosity 80W90.

- Enhanced extreme pressure and anti-wear properties.
- Anti-foam capacity.
- Compatible with non-ferrous metals.

Drum	209 l	546220
Drum	55 l	546221

Can	20 l	546330
Can	5 l	720184
Can	2 l	499237



Transmission Oil EP140

High quality oil for the lubrication of mechanical transmissions.

- Complete protection against wear, corrosion, foam, rust and oxidants.

Can	20 l	582362
-----	------	---------------



Transmission Oil Trans LS

For limited-slip axles and differentials. Recommended for MLA type MANITOU loaders.

- Significant anti-rust and antioxidant capacity.
- Increases service life of components.
- Excellent heat resistance.

Drum	209 l	661972
------	-------	---------------

Can	20 l	582361
-----	------	---------------

Advice

Unsure about oil contamination? Ask for an oil analysis, see p.35.





Manitou AXLE OIL

A MANITOU axle incorporates immersed brakes and a differential. These mechanisms are subject to strong pressures, particularly during repeated braking, long driving periods, or intensive use. That is why adequate lubrication is needed.

Why use a MANITOU axle oil?

MANITOU automatic transmission oil is specially formulated for automatic transmissions and torque converters. It delivers high anti-wear performance, low pour point, high anti-oxidant capacity and compatibility with all MANITOU seals.

The MANITOU special immersed brake oil is specially formulated for the components containing the immersed brakes. It is characterized by extreme pressure resistance properties, excellent anti-wear and anti-foam properties, and very good stability in service.

Advice

Recommendations

MANITOU transmission oil allows precise, rapid and smooth gear changing, whatever the ambient temperature. Gearbox technology has evolved considerably in recent years. It is necessary to minimize wear on your machine's transmission components to extend their service life. Transmission oil has become more and more efficient, and is a major element in the proper functioning of your MANITOU.



Special Oil for Immersed Brakes

For MANITOU axles with immersed brakes.

- Cools the braking system and ensures smooth braking.
- Enhanced anti-wear and extreme pressure capacity.
- Reduces formation of particles.

Drum	209 l	894257
Drum	55 l	947918
Can	20 l	582391
Can	5 l	545976



Oil Additive for Immersed Brakes

Concentrated additive to add to Special Immersed Brake Oil when changing the oil. Anti-wear properties.

- Excellent pressure resistance.

Can	1 l	546034
-----	-----	---------------



Mineral oil brake fluid- LHM

High quality lubrication that provides exceptional protection for your braking system.

- Significant anti-shearing power.

Can	1 l	490408
-----	-----	---------------



Lockheed Dot 4 synthetic oil

For braking systems other than LHM.

Can	30 l	486364
Can	1 l	786653
Can	0,5 l	473013



Drain plug

Ø 19 mm. Brass.

Operates with :

- Connector (Ref. 525416)
- Hose (Ref. 78218).

212946



Rapid drain valve

Speed up your oil change time! Compatible with MANITOU forklifts fitted with Perkins engine E1, E2 and E3 :

- EURO 1 type: 1004.4 and 1004.4T.
- EURO 2 type: 1104.4 and 1104.4T.

Thread 3/4-16.

554054



Greases & Lubricants

Servicing & Maintenance

Manitou GREASES AND LUBRICANTS

For more reliable machines and optimum performance!

Greasing

- Reduces wear on mechanical parts subject to friction.
- Creates a watertight barrier against external elements (dust, water, solvents and heat).
- Forms a constantly available supply of lubricant.
- Reduces heat and energy loss due to friction.

MANITOU offers you a selection of lubricants that will provide effective solutions for all your greasing and lubrication needs.

Advice

Greasing frequency

Refer to our manufacturer's recommendations: available through your dealer or User manual.



MANITOU multi-purpose grease

Blue grease for general lubrication of the forklift.

- Resistant to high temperatures.
- Withstands heavy loads and shocks.
- Insoluble, highly adhesive.
- Protects against corrosion.

Pots	50 kg	958176
Pots	20 kg	958177
Pots	5 kg	554974
Cartridge	400 g	161589



BLACK G ULTRA Special Grease

General use

Lubricant for open gears, chains, metal cables.

- Deposits a uniform, highly adhesive film. Recommended for heavy duty applications.
- Anti-corrosion protection.
- Waterproof, and resistant to acids and saline solutions

Aerosol	500 ml	958178
---------	--------	---------------



MANITOU Multi-Purpose Extreme Grease

General use

High quality multi-purpose EXTREME PRESSURE grease. Use on components subjected to shock and vibration. Suitable for bearings, points, articulations, wheel bearings, suspensions, etc.

- Versatile.
- Insoluble in water, easy injection.
- Resistant to temperatures from -20° to 130°.

Cartridge	400 g	947765
Pots	5 kg	554974



Anti-Seize copper lubricant

General use

For all parts operating at very high temperatures: stud-bolts, exhaust manifold nuts, turbocharger screws, steam connections, etc. Special lubricant containing graphite and metal salts. Color copper.

- Permitted temperatures: -80°C to +120°C.
- Good resistance to chemicals.
- Does not contain lead.
- Aerosol with ecological propellant.

Aerosol	520 ml	479293
---------	--------	---------------



MANITOU special multi-purpose grease

Special chains lubricant

White grease, lubricant for chains, axles, cables and springs. Recommended for environments with strict hygiene standards.

- Resistant to heat, water and saline solutions.
- Anti-rust properties.

Aerosol	500 ml	479329
---------	--------	---------------



Dry anti-wear grease

Special Bearings

Lubricant for jibs, sliders and gears in the presence of oxygen or in a vacuum. Deposits a thin, dry film. Recommended by MANITOU for the protection of slider masts.

- Withstands a pressure of 7,000 kg/cm².
- Can withstand high temperatures of up to 450°C.

Aerosol	400 ml	483536
---------	--------	---------------



MANITOU Special Chains lubricant

Special Chains Lubricant

Designed specifically for greasing masted forklift trucks.

- Maximum lubrication of contact surfaces.
- Maximum penetration of fibres.
- Minimal adhesion of dust and links.
- May be applied to chains while operating.
- Water resistant.

Aerosol	400 ml	554271
---------	--------	---------------

Advice

To apply the greases, see our range of tools: see following pages.



MANITOU multi-purpose graphite grease

Special Masts

Black grease to lubricate and protect mast lifts. Ideally suited to damp and corrosive environments.

- High melting point.
- Extreme pressure properties enhanced by molybdenum disulphide.
- Protects against rust.

Pots	50 kg	499235
Pots	1 kg	161590
Cartridge	400 g	947766



Nyogel Grease

Special Connectors

Improves connector conductivity.

Tube	760 g	662438
------	-------	---------------



Chain lube

Special High Speed

Highly adhesive grease, water-insoluble, for high acceleration and high speed. All mechanisms, electromechanical tools, hydraulics, tires and chains. Mineral oil, lithium soap, EP additive, adhesive, viscous. Compatible with seals, metals and humid and warm atmosphere.

- Permitted temperature range: -30°C to +170°C.
- With ecological propellant.

Aerosol	400 ml	479294
---------	--------	---------------



Silicone Lubricant

Special Seals

- Facilitates sliding of windows, prevents door and hood seals from drying out and sticking.
- Maintains door articulations, hinges and runners.
- Compatible with all coated materials and surfaces. Color black
- Plant mineral oils and aliphatic solvents.
- Wetting agents, deoxidizers.
- Ecological propellant.

Aerosol	400 ml	479292
---------	--------	---------------



Super TefLube Lubricant

Special Plastic

PTFE properties to greatly reduce friction factor. Long-lasting lubrication of plastic or composite parts.

- Use: -50°C to +265°C.

Aerosol	400 ml	719741
---------	--------	---------------



MANITOU multi-services light grease

General use

Suitable for all type of mechanisms operating under moderate load.

- Easy to inject.
- Anti-rust and anti-corrosion.

Cartridge	400 g	744641
-----------	-------	---------------

Greasing & Lubricant attachments

Servicing & Maintenance



Oil distribution system with pump

Oil set with pump 3/1 on barrel, with 4 m hose and handle with digital counter, non-drip spout. Standard transportation truck.

744907



Hand-lever pump

Hand-lever oil pump with telescopic rod to fit drums and kegs.

- Facilitates lubricant distribution.

744906



Mini-lube grease pump

Stand-alone mechanical manual pressure lubricator. Permits greasing without compressed air and in high pressure (up to 700 bar). 1.5 m hose and booster gun to reach the most inaccessible lubricators. Portable device, lightweight and economical to use.

Comes with 5 kg durable plastic filling pail.

- 5 kg refillable pot of grease (Ref: 554974).

545830

Advice

Oil test kit

Oil testing kit to:

- Make a diagnosis of your engine.
- Check the pollution level of the oil.
- Identify causes of breakdowns.
- Determine oil requirements.

Available following countries. ASK YOUR MANITOU DEALER FOR ADVICE.

Advice

Fuel test kit

Fuel testing kit to:

- Make a diagnosis of your engine.
- Check the pollution level and fuel quality.
- Prevent significant performance reduction of the engine.

Available following countries. ASK YOUR MANITOU DEALER FOR ADVICE.



Electric grease gun

Powered by a rechargeable battery. Uses grease cartridge or loose grease. Operation pressure 250 bar.

- Kit includes: 1 x 220v battery charger.
- 2 rechargeable batteries.
- 1 hose and hydraulic coupler.

788001



Grease Gun

Lightweight and easy to use, it facilitates all lubrication operations with its mechanical qualities and long-lasting performance.

Weight without grease: 1.3 kg. Ergonomic handle and removable base to:

- Increase compression
- Facilitate insertion of cartridges.

661591



Lever grease pump

Cast iron head.

- Use for 400g grease cartridge and loose grease.

Standard model	38720
Polyamide hose	164388
Hose nozzle	164389



Lever pump

Cast iron head with non-return valve.

Air valve and filler valve diam.12.5 mm.

- Use for 400g grease cartridge and loose grease.

Industry model	788307
Rubber hose	788352
Hose nozzle	164389





Manitou **FILTRATION** **OUR RECOMMENDATIONS**

MANITOU filters: a range of high quality, high-performance filters.

MANITOU filters are perfectly suited to your machine's needs. Designed specifically, MANITOU filters are developed and qualified for your machine type. Compatible with your working environment, they ensure maximum efficiency.

MANITOU parts claim superior qualities and allow engines to withstand very variable atmospheres: humidity, dust, high and low temperatures, and significant internal stresses (extreme temperatures, flow, high pressure, etc.).

You now have access to more than 750 items, in order to offer you a longer service life, MANITOU filters have a high resolution filter medium, with the finest filtration, and a bigger filter surface than a standard filter.

With their high dust and particle retention capacity, they protect key components of your forklift against damage and ensure the longevity of your machine.

Replacement frequency

- To maintain the original qualities of your MANITOU machine, it is essential to follow the filter replacement intervals.
- Simplify servicing and enjoy all the advantages of MANITOU's know-how by subscribing to a service contract.
- Find out more.

	Daily -10 hrs	1 year - 500 hrs	1 year - 1000 hrs
Pre-filter clean	Clean		
Air filter clean		Replace	
Air filter safety cartridge			Replace
Fuel filter		Replace	
Engine oil filter		Replace	
Transmission oil filter		Replace	
Hydraulic fluid return filter		Replace	
Hydraulic pump filter		Replace	

• Indicative data may vary according to model type. Always refer to the specific service manual for each machine. Consult your MANITOU dealer.



Why choose MANITOU filters?

Because they ensure:

- Quick and easy installation on your machine.
- Economy: less frequent replacements.
- Security: performance matches your machine.
- Rapid delivery time: international logistics and network.
- Manufacturer's guarantee.

Oil filter

The oil filter is essential to the proper functioning of the engine. It continuously traps external impurities (dust, sand, volatile elements, etc.) and internal impurities (carbon deposits and engine wear particles) and plays an active part in cleaning the engine.

Why change the oil filter?

If you do not replace your filter regularly, there is a high risk of clogging, resulting in poor lubrication and premature wear of your engine.

Fuel filter

The quality choice: As well as filtering out impurities, MANITOU fuel pre-filters are involved in extracting water contained in the diesel. Water is heavier than oil and separates out into the pre-filter's water tank. The diesel, which is lighter, is filtered, then directed to the main filter. Reliable separation of water and diesel helps to extend the service life of the engine's sensitive components (injection pump, fuel injectors) by protecting them from corrosion. The main filters have a high capacity to filter out the finest particles, meeting the increased requirements of the new motorization standards.

MANITOU fuel filters incorporate in the same system filtration, water separation, heating and cooling down of fuel. Our fuel filters are guaranteed to be pressure-resistant, even in the lowest temperatures, or during startup. In all circumstances, they ensure a supply of clean fuel.

Why change the fuel filter?

A well-maintained fuel filter is essential for proper functioning of the engine. It ensures protection of all the engine's components and long-lasting performance of your MANITOU machine. It also has a positive impact on fuel consumption. For the proper functioning of your engine, your fuel filters should be changed every year or every 500 hours of service.

Hydraulic filter

The hydraulic oil circuit involves more than 100 litres of oil. Hydraulic oil filters are important, because they act as the machine's kidneys. The slightest particle of contamination, such as sand, welding spatter, fibres, particles of metal or even rust may damage a pump and the components of the hydraulic system. Hydraulic filters are usually installed on the return-to-tank circuit in order to capture the impurities generated or introduced into the circuit. Failure to adhere to the hydraulic filter changing schedule may lead to malfunction, premature wear, or even breakage of components. MANITOU has developed the performance of its filters by offering you a "High-Efficiency" hydraulic cartridge for an improved filtration quality. These cartridges increase filtration capacity for enhanced protection of your components.

Air filter

The function of the air filter is to protect your engine from attack by external contaminants. An engine can take in up to 500 cubic m^{etres} of air every hour. That air is more or less contaminated with impurities, depending on the environment (the country, climate, season, area of development). This contains dust, which eventually forms an abrasive paste that threatens the engine's functioning. It is recommended to wash the air filters very regularly, and to replace the main filter every six months (500 hours) and the safety filter every 12 months (1000 hours).

Why change the air filter?

An air filter that is clogged or in poor condition may cause malfunctions and therefore premature wear of the engine. Loss of vehicle performance. Increased fuel consumption. Increased emission of polluting gases. To maintain the MANITOU performance level, replacement and servicing schedules must be adhered to. Carrying out preventive maintenance ensures cost efficiency!



FILTER KIT for the maintenance of your machine after 500 hours and 1000 hours

Specially adapted to your machine, the filter kit contains all the elements needed for the regular maintenance of your MANITOU machine (except oil). In accordance with the manufacturer's recommendations, it is a complete pack, with peace of mind guaranteed and an attractive price.

The 500-hour kit contains:

- Oil filter
- Air filter
- Gasoline pre-filter
- Gasoline filter
- Transmission filter
- Hydraulic filter

(Standard kit, excluding specific machine, may vary according to machine. Always refer to MANITOU operating instructions).

The 1000-hour kit contains:

The same as the 500-hour kit + 1000-hour specific additions:

- Safety cartridge
- Air filter

Examples of filter kits according to your MANITOU machine:

Advice

There are more than 253 items to cover almost 126 types of machine:
CONTACT YOUR DEALER, TO BE SURE TO FIND A KIT THAT SUITS YOUR NEEDS!

MLT	pack	Kit 500 h	DEUTZ Engines	MLT 634 120 ST3B / MLT 634 120 PS ST3B / MLT 735 100 ST3B / MLT 735 120 ST3B / MLT 735 120 PS ST3B / MLT 741 100 ST3B / MLT 741 120 ST3B / MLT 741 120 PS ST3B	947843	
		Kit 1000 h			947868	
	pack	Kit 500 h	KUBOTA Engines	MLT 625-75 H ST3B / MT 625 H COMFORT ST3B / MT 625 H TURBO ST3B	958519	
		Kit 1000 h			958534	
	pack	Kit 500 h	JOHN DEERE Engines	MLT 840 137 ST3B / MLT 840-115 PS / MLT 840-137 PS	947858	
		Kit 1000 h			947883	
	pack	Kit 500 h	PERKINS Engines	MLT 735 120 LSU POWERSHIFT S6 / MLT 634 -120 LSU Série F-E3 / MLT 634 -120 LSU POWERSHIFT Série F-E3 / MLT 735 -120 LSU Série 6-E3 / MLT 735 -120 LSU POWERSHIFT Série 6-E3 / MLT 741 -120 LSU Série 6-E3 / MLT 741 -120 LSU POWERSHIFT Série 6-E3	947835	
		Kit 1000 h			947860	
	MT	pack	Kit 500 h	DEUTZ Engines	MT 732 ST3B / MT 732 ST3B / MT 932 ST3B	947859
			Kit 1000 h			947884
pack		Kit 500 h	PERKINS Engines	MT1840 PRIVILEGE / MT 1440 PRIVILEGE / MT 1440 EP PRIVILEGE / MT 1840 PRIVILEGE / MT 1840 EP PRIVILEGE	947845	
		Kit 1000 h			947870	
pack		Kit 500 h	PERKINS Engines	MT835 ST3B / MT835 ST3B / MT1135 ST3B / MT1335 ST3B	958443	
		Kit 1000 h			958444	
M	pack	Kit 500 h	PERKINS Engines	M26-2 ST3B / M30-2 ST3B / M26/30-4 ST3B / M40/50-2 ST3B / M40/50-4 ST3B	958333	
		Kit 1000 h			958338	
MI	pack	Filter kit 500H	YANMAR Engines	MI 20 D S2 / MI 25 D S2 / MI 30 D S2 / MI 35 D S2	958524	
		Filter kit 1000H			958539	
ATJ	pack	Filter kit 500H	KUBOTA Engines	180 ATJ RC E3 / 160 ATJ PLUS Euro 3 / 180 ATJ Euro 3 / 180 ATJS Euro 3	947854	
		Filter kit 1000H			947879	

Advice

Manitou cares about the maintenance of your machine: subscribe to a Comfort service contract, see chapter Services & Solutions.

How to recognize MANITOU genuine filter ?

MANITOU oil filters, with genuine quality, have a higher dirt holding capacity. With a longer service life, genuine filters are three times more resistant to mechanical loads. Genuine oil filters are also equipped with a bypass valve to ensure lubrication and avoid oil leakage and risks of total engine failure.



MANITOU genuine filter

1. Defined pleat spacing, high pleat stability and approx. 15% more filter surface area.
2. Reliable and accurate sealing.
3. Correct valve opening pressure for the application.
4. The middle tube is perfectly stamped from one piece of sheet metal.



Non-genuine filter

1. Reduced dirt holding capacity through wavy filter media and smaller surface area.
2. Low dimensional accuracy leads to leakage.
3. Valve opens prematurely and unfiltered oil reaches the engine which in the worst case can lead to total engine failure.
4. The middle tube consists of pieces of sheet metal wound diagonally. Rough metal seams can damage the filter paper and cause leakage.



TURBO Pre-filter

Pre-filter with Cyclone technology: captures up to 98% of impurities in the air before it enters the main air filter. Self-cleaning system: maintenance-free. For diesel engine power 18 to 186 kW.

- Increases service life of main air filter
- Reduces maintenance costs.
- Simple, rapid installation.
- Large air inlet surface area.

Specific features of Turbo II:

- Stainless steel.
- Black galvanized paint.
- Proven toughness.

Specific features of Turbo III:

- Nylon coating for exceptional durability.
- Excellent resistance to vibrations and temperature (110°C).

Model 3' - 35 to 93kW (Turbo II)	160946
Model 4' - 35 to 93kW (Turbo II)	223510
Model 4.5' - 88 to 132kW (Turbo II)	160947

Model 3' - 18 to 93kW (Turbo III)	744588
Model 4.5' - 73 to 186kW (Turbo III)	906126

Advice

Feel free to ask your MANITOU dealer for advice.



Cyclone pre-filter

Essential attachment for better air filtration in dusty or humid atmospheres.

- Reduces fuel consumption.
- Reduces clogging of air filters

224713



Air Pre-Filter

Self-cleaning pre-filter:

- Continuous removal of impurities: maintenance-free.
- Specially developed for difficult weather conditions.
- Reduces fuel consumption and increases service life of air filters.

Self-cleaning pre-filter for MT, MLT and M/MC.

226611

Self-cleaning pre-filter for TMT, CD/CG, MSI.

240334



Pre-Filter Tank

Reserve tank for pre-filter ref. 224713.

224927



Fuel filter funnel

Filters out impurities in the fuel during decantation. It separates the water and filters out various hydrocarbons, such as diesel, kerosene, petrol and oil.

- 3 different outputs.
- Filtration 50 pm.

11 l / min

787211

17 l / min

787212

22 l / min

787213



Water/gasoline separator decanter filter

Filters the gasoline and separates the water into a bowl to protect the injection elements (pump and injectors).

- Transparent bowl to check the presence of water and the need for draining.
- Process facilitated by purge screw or valve.

For example, refer to your Manitou dealer to fit the specific model to your machine.

254843

Advice

Refer to your instruction manual to find the model specific to your MANITOU machine. Your dealer is there to help you. Don't hesitate to ask for advice.

Liquid Coolants & Starting Aid

Servicing & Maintenance



MANITOU organic liquid coolant -35°C

High quality, ready to use liquid to optimize cooling performance and provide protection to -35°C. Inhibitor system based on use of organic molecules, which create a protective film on the metal contact areas.

- Long-lasting protection of engines and metal radiators against corrosion.
- Can be used all year round.
- Improves thermal transfer to coolant.

Can	5 l	894967
Can	20 l	894968
drum	210 l	894969



ADBLUE

An aqueous solution consisting of 32.5% urea and 67.5% demineralized water. For vehicles equipped with SCR (Selective Catalytic Reduction) technology: heavy goods vehicles, buses, and MANITOU SCR technology machines.

- Converts 85% of pollutants (nitrous oxide or NOx) into harmless nitrogen and water vapor.
- Reduces harmful nitrogen oxide emissions.

Complies with Euro 4, Euro 5 and Euro 6 standards for the reduction of pollutant emissions.

Can	10 l	958575
drum	200 l	958576



Gasoline anti-freeze GNR

Lowers the freezing point of gasoline and domestic fuels. Counteracts the development of ice and paraffin **crystals**.

- Ensures greater energy efficiency.
- Helps keep the whole injection system completely clean.
- Protects the injection system against corrosion. Reduces fumes.

Can	1 l	895454
-----	-----	---------------



Starting fluid

Assists starting of older types of petrol and diesel engines.

Aerosol	250 ml	479332
---------	--------	---------------



MANITOU organic liquid coolant, type D -25°C

Developed for long-lasting protection of aluminum radiators.

- Integrated leak detector.
- Protection to -25°C.

Can	1,5 l	894508
Can	5 l	788246
Can	20 l	788247
Can	210 l	788248



Anti-bacterial additive for diesel

Destroys bacteria, algae and mildew. Prevents clogging of filters, soiling and breakage of injectors. Does not affect the quality of the fuel. Can be used for both gasoline and domestic fuel.

- Fuel stabilizer keeps fuel fresh for 24 months. Treats 250 litres.
- Reduces pollutant exhaust emissions.
- Prevents drying out of seals.

Can	250 ml	53009479
-----	--------	-----------------



Fuel decongealant

Equipped with a resistor, this attachment warms the gasoline before it reaches the engine filter, preventing clogging and stalling of the engine. Recommended from -15°C. For MLT/ MT.

699231

Advice

Consult your dealer to find out if this attachment is compatible with your engine.

Mechanical Maintenance

Servicing & Maintenance



Leak detector

Air or gas leaks. For use on all gas, compressed air, LPG, butane and propane gas pipes and tanks. Rapidly detects leaks in connectors and weld seams on all gas systems, air brakes, and compressors.

- Non toxic.
- Nonflammable, does not contain halogenated solvents.
- Contains an anti-corrosion agent.
- Aerosol with ecological propellant.

Aerosol	400 ml	471553
---------	--------	---------------



Crack detection kit

Detects cracks and faults on weld seams and metal surfaces. Recommended for inspecting forklift masts. Contains:

- Degreasing cleaner,
- Colored fluid for tracking.
- Indicator to show up the coloured cracks.

To be used for forks for example. See machine attachments pages for Manitou fork range.

Pack of 3 aerosols	500 ml	781572
--------------------	--------	---------------



Seal cleaner

For cleaning seal surfaces. For use on metal surfaces, wood and plaster. Not for use on plastics or synthetic fibres.

- Rapidly unsticks old seals.
- Dissolves seal paste and carbon, grease and paint deposits.
- For use before applying sealing products.

Aerosol	400 ml	582695
---------	--------	---------------



Cleaner and degreaser

For preparing surfaces prior to gluing. Removes all traces of grease after wiping surfaces or other less powerful solvents, such as petrol, gasoline, or white spirit.

- Dry solvent.
- Evaporates rapidly to allow immediate application of glues and adhesives.

Aerosol	520 ml	582662
---------	--------	---------------



Contact cleaner

Degreasing agents for lugs, terminals, cable clamps, relays.

- Removes moisture and water smears.
- Does not damage insulation materials or affect their electrical properties.
- Improves functioning of contactors and terminals.

Aerosol	400 ml	744812
---------	--------	---------------



Brake cleaner

For cleaning brake drums, pads and discs,

- Rapidly dissolves and removes oil, grease and fluid from brakes.
- Penetrates dirt and corrosion.
- Restores brake efficiency without requiring disassembly.
- Non-corrosive to metals.

Aerosol	600 ml	582350
---------	--------	---------------



Penetrating oil

Super-concentrated penetrating oil containing molybdenum disulphide.

- Quickly releases parts locked by rust.
- Deposits a lubricating film.
- Protects against further corrosion.

Aerosol	500 ml	479323
---------	--------	---------------



Mild industrial cleaner

Rapid-action powerful cleaning agent. Removes grease, glue and dirt without leaving any traces. May be used on a variety of materials, including plastics. Can be sprayed in any position, even upside down.

- Excellent penetration without harming delicate surfaces.
- Ideal for preparation of surfaces for painting, gluing or repair.

Aerosol	500 ml	788336
---------	--------	---------------



Degreasing cleaner

Concentrated degreasing cleaner, biodegradable. Clean, environmentally friendly product, non toxic, non flammable, phosphate-free.

- Various applications: may be used in different concentrations according to cleaning and degreasing requirement for professional purposes.
- May be used in high pressure cleaning machines.

Sprayer	750 ml	582681
Can	5 l	582680
Can	20 l	582679



Anti-rust

Anti-corrosion treatment. Protects cavities from the inside out, ensuring that treated parts remain intact.

Aerosol	500 ml	787695
---------	--------	---------------

Bodywork Maintenance

Servicing & Maintenance



Window repair kit

Rapid bonding of windows, single-component polyurethane adhesive sealant. Quick-setting. TÜV approved, after crash test. Contains: 1 primer (10 ml).

- 1 primer applicator.
- 2 nozzles.
- 1 cleanser (20 ml).
- 1 cloth.
- 1 positioning wedge and instructions for use.
- 1 cartridge of window adhesive.

Complete kit **505568**



Black gasket

Sealing, filling, soundproofing. Repairing seals, grommets, casings, heating and ventilation pipes.

- Very high viscosity. Temperature resistance: -50°C to +250°C
- Fast setting: 1 hour.

Tube 100 ml **485261**



Seal adhesive

Heavy-duty gluing of door and window seals. Clear silicone sealant.

Sealant for windshields, signal lights. Insulation of wire and electrical appliances. Good resistance to water, oil and antifreeze.

- Very high viscosity.
- Temperature resistance: -50°C to +250°C.
- Ready for use: bonds in one hour.

Tube	45 g	466215
Tube	100 ml	471566
Cartridge	310 ml	505574



Neoprene glue

Thixotropic neoprene glue gel. For rubber, leather, soundproofing or insulating felt, laminates, wood, metal, etc. Medium viscosity, non-stringy.

- Applied on both parts, join together after ten minutes.
- Rapid and solid bonding.
- Ensures a clean, simple job.

Tube 100 ml **470615**



Anti-wear and anti-pollutant treatment

Versatile injection treatment, multi-purpose, anti-wear and anti-pollution.

- Increases service life of treated components.
- Reduced fuel consumption.
- Reduces oil temperature increase by 20%.
- Protects seals with improved airtightness.
- Lubricating properties are retained.

MOTOR-ECO Syringe	60 ml	745006
INJECT-ECO Syringe	60 ml	745007
TRANS-ECO Syringe	60 ml	745008

Advice

Feel free to ask your MANITOU dealer for advice.



Super glue liquid

Multi-purpose liquid adhesive. For substrates such as metal, rubber, wood, cardboard, ceramics and most rigid plastic.

- Very strong.
- Low viscosity.
- Bonds in seconds.

Tube	3 g	466213
Bottle	5 g	545596
Bottle	20 g	489986



Bodywork glue

Aerosol adhesive with no chlorinated solvent: fabric, leather, cardboard, canvas, vinyl, sound-proofing panels, rubber, foam, interior roof trim.

- Very strong instant hold.
- Multi-position nozzle.

Aerosol	400 ml	554316
---------	--------	---------------



Elastomer adhesive - any material

For structural bonding on the bodywork of cars, industrial and commercial vehicles. This single-component structural adhesive has excellent hold, without primer, on many substrates and materials: painted surfaces, steel, aluminum, brass and most plastics.

- Very strong with rapid hold.
- UV-resistant and resistant to aging. Low shrinkage.
- Can be applied to wet surfaces.

Tube	310 ml	582151
------	--------	---------------



Elastomer adhesive - windows

Polyurethane elastomer adhesive with high viscosity. Is turned into elastomer by the action of air and atmospheric moisture.

- Glues surfaces that have to withstand vibration.
- Particularly suitable for gluing windows.
- The shape of the seal is determined by the shape of the extrusion tip.

Tube	310 ml	183385
------	--------	---------------



Protective spray for metal parts

Protects crude or machined metal against corrosion for up to six months. Forms a resistant film. Increased protection obtained by application of several layers. Protects metal against splashes of products such as cement and plaster.

- Drying time: around 30 to 45 min.

Aerosol	400 ml	554074
---------	--------	---------------







THREADLOCKER® normal

Braking and sealing of all threaded components. Excellent vibration resistance. Easy to use.

- Withstands temperature: from -55°C to +150°C.
- Polymerization at 22°C: 10 to 30 min maximum resistance: 3 hours.
- Colour: blue.

Tube	5 ml	661716
Bottle	24 ml	466222
Bottle	50 ml	187526

MANITOU special paints

	MANITOU Beige	Aerosol	400 ml	473071
		Pot	1 kg	786658
		Pot	5 kg	62121
	MANITOU Red (pre-2004)	Aerosol	400 ml	62133
	MANITOU Red (post-2004)	Aerosol	400 ml	719941
		Pot	1 kg	720287
		Pot	5 kg	720288
	MANITOU Brown	Aerosol	400 ml	505506
		Pot	1 kg	786648

Attachments

	Colour: Black satin	781888
--	---------------------	---------------

Cabin

	Colour: MANITOU Brown	786648
--	-----------------------	---------------

Logo on counterweight

	Colour: MANITOU Beige	786658
--	-----------------------	---------------

Anti-rust paint (Brown/red)

	Aerosol	400 ml	483541
	Pot	1 kg	786654
	Pot	5 kg	786660

MANITOU wheel hubs & rims

	Colour: Beige	473071
---	---------------	---------------

MANITOU hubs

	Colour: Black satin	Pot	1 kg	781888
---	---------------------	-----	------	---------------

Axle

	Colour: Black gloss	786656
--	---------------------	---------------

Bodywork

	Color: MANITOU Red	720287
---	--------------------	---------------

MANITOU rims

	Colour: Gray gloss	Aerosol	400 ml	786586
---	--------------------	---------	--------	---------------











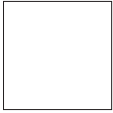

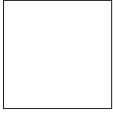
Door

	Colour: Gray gloss	Aerosol	400 ml	786586
---	--------------------	---------	--------	---------------

Colour chart

	Chart of available paint colours	894795
---	----------------------------------	---------------

Paints other

	Hardener	Pot	1 kg	947176		Galvanizing paint matte	Aerosol	500 ml	554698
		Pot	5 kg	661745			Aerosol	400 ml	786586
		Pot	10 kg	661746			Aerosol	400 ml	483542
	Varnish	Aerosol	400 ml	554074		Gray gloss	Pot	5 kg	786655
		Aerosol	400 ml	483542			Pot	1 kg	490113
	White	Pot	1 kg	786657		Gray matte	Aerosol	400 ml	505679
	Beige cream	Pot	1 kg	786665			Pot	1 kg	490113
	Buff	Aerosol	400 ml	546235		Black matte	Aerosol	400 ml	505679
		Pot	5 kg	546225			Pot	1 kg	781888
	BRAUD FAUCHEUX blue	Aerosol	400 ml	62134		Black satin	Pot	5 kg	554085
		Pot	1 kg	786662			Pot	1 kg	786656
	Galvanizing paint gloss	Aerosol	400 ml	62118					



Advice

To maintain your machine's external attributes, MANITOU offers a complete range of paints for the regular maintenance of your bodywork. Think of resale: a glossy machine, protected from dirt, increases the value of your equipment!

Interior & Exterior Maintenance

Servicing & Maintenance



De-icer

Removes frost and ice from all windows and windshields.

- De-ices locks blocked by ice.

Aerosol

250 ml

485243



MANITOU Windshield Washer -20°

Ready to use. Special Winter -20° for de-icing windows. Completely biodegradable bio-alcohol base. Contains bittering agent to counter risk of ingestion.

- Summer: cleans, degreases, anti-static, anti-mosquito. Ensures perfect visibility.
- Winter: Use undiluted, anti-frost, anti-ice action to -20°C.

Can

1 l

490402

Can

5 l

486424



Multi-purpose cleaning foam

For cleaning seats, carpets, door coverings, windows, removal of insect smears on windshield and headlights. Cleaning of chrome, painted and plastic parts.

- Removes traces of exhaust gas.

Aerosol

300 ml

505575



Hand cleaning cream

Hand cleansing cream (for mechanics). Gentle formula, biodegradable, citrus oil-based with pumice stone powder, contains no petroleum solvent. Can be used with or without water, and does not leave hands greasy.

- PH conforms to standard NFT 73102.

Bottle	400 ml	947153
Bottle	3 l	947152



Microbead soap

Red microbead gel for washing hands. Removes paint, tar, resin, ink, grease.

- Conforms to standard AFNOR 73102.

1 l	489955
4,5 l	479322



Floor absorbent

Chemically inert, sterile, non-polluting, non-flammable.

Can be applied to any greasy or slippery floors.

- Absorbs liquid and forms a protective coating.
- Easily removed by sweeping.

Powder	20 kg	554233
Granules	20 kg	483537
Diatom?	20 kg	554701



Paper towel roll

Soft, absorbent and very strong, these rolls of high quality paper are perfect for drying hands.

499239



Hand wipes

30 wipes for cleaning hands. Effective on grease, oil, tar, ink, etc.

- Non-toxic, non-irritant.

895179



Soap gel

Microbead gel for washing hands. Fully biodegradable.

- Polyethylen cartridge.
- Pleasant fragrance.

4.5 l **546069**





**TYRES, CHAINS
& HYDRAULIC
COMPONENTS**

Pneumatic Tyres	54
Pneumatic Shaped Solid Tyres	58
Lifting Chains	60
Hydraulic and Wearing Components	61



Pneumatic Tyres

Tyres, Chains & Hydraulic Components

Manitou PNEUMATIC TYRES

The reliability of your all-terrain material handling equipment depends first and foremost on the state of the tyres. As the only point of contact between the ground and the machine, the tyre requires a level of sophistication and a choice approved by the manufacturer to ensure the safety of the operator, the machine's performance, and the tyre's longevity. All our tyres are tested and approved by our design office, in accordance with our specifications: sidewall damage resistance, vibration reduction, choice of tread design for maximum traction, and, very importantly, longitudinal and lateral safety and stability of your machine. MANITOU has chosen major brands as partners to offer you a wide range: radial or diagonal pneumatic tyres, pneumatic shaped solids, wheel rims, complete wheels, etc. MANITOU can fulfill all your requirements: make sure you choose the right tyres! Follow Manitou recommendations and choose only approved tyres for your machine. Ask your dealer for advice.

The key strengths of our selection

- Durability
- Grip
- Precision
- Handling
- Even Wear Comfort
- Stability

Characteristics of your tyres

- Type
- Size
- Wear Index Rolling
- Direction

When should you replace the tyres on your MANITOU?

- Check the tread depth.
- Check the appearance of the tread and sidewalls.
- Check the sidewalls: no deep tears or cord showing.
- Replace the valve each time the tyre is changed: it guarantees watertightness and contributes to the durability of your tyres.
- Check tyre pressure regularly when tyres are cold: improper inflation causes premature wear and higher fuel consumption.

How do you choose the tyre that fits your requirements?

Every item of MANITOU equipment has been approved with a specific design and type of tyre. In order to conform with safety standards and the various load charts, it is essential to follow MANITOU recommendations.

MANITOU's commitment to the environment

MANITOU has established a strict waste management system for each branch: every dealership sorts the waste materials generated by its mechanical activity and takes part in reusing, recycling or recovering them.



A 325 - Diagonal

Robust and stable.

- Shock and puncture resistant due to the nature and quantity of casing plies.
- Tear-resistant due to thickness, quality, and protective rubber compounds and tread patterns.
- Solid stability: high rigid sidewalls (vertical and lateral).

CONSTRUCTION: All-terrain - mixed surfaces



A 570 - Radial

For agricultural applications. Steel and polyester casing.

- Strong traction on soft surfaces due to its specific profile.
- Driving comfort on hard surface.
- For speed <25 km/h (machines not HRT certified).

AGRO INDUSTRIAL: All-terrain - soft ground



A 580 - Radial

For agroindustrial applications. Steel and polyester casing.

- Very good grip and high performance on soft surfaces.
- Driving comfort and efficiency on hard surfaces.
- Good road-holding.
- Optimized fuel efficiency.

For HRT certified machines (roads).

AGRICULTURAL: All-terrain - mixed surfaces



XMCL - Radial

For compact telehandlers, backhoe loaders and compact loaders.

Very good technical performance :

- Conception : Lug depth, protective steel crown plies, sidewall protective band and new design.
- Great stability and comfort.
- Excellent puncture resistance, long service life.

AGRICULTURE: All-terrain - soft ground



POWER CL - Diagonal

For agricultural and industrial machines.

- Damage resistant tread.
- Closely spaced central tread pattern and specific rubber compound to reduce risks of puncture and tearing.
- Excellent sidewall stability: crossply construction and angled plies for stability of elevated loads.

AGRICULTURE: All-terrain - soft ground



XHA - Radial

Suitable for loaders, on rough surfaces, with heavy loads.

- Very good lateral stability.
- High wear resistance.
- Reduction of hourly costs and saves on fuel.

INDUSTRIAL: All-terrain - hard floors



BIBLOAD HARD SURFACE - Radial

For agro-industrial use : innovative diamond sculpture technology for high load capacity, stability and durability.

- Large contact patch due to its 96 tread blocks
- Reduced vibrations.
- Optimal traction on the road and on slopes.
- Highly resilient with reinforced sidewalls.

AGRICULTURE / CONSTRUCTION - hard surfaces



Anti-puncture concentrate

- Prevents and seals punctures instantly with permanent waterproof seal.
- Seals holes in the tyre tread with diameter < 7 mm.
- Reduces travel expenses, costly downtime and puncture repair costs.
- Prolongs service life of tyres.

Concentrate	Can	25 l	787842
For manual injection pump			545580



Continental

MPT 70 - Radial

- For heavyduty, allterrain applications, on small and large construction sites.
- Sturdy tread pattern, ideal for construction.
- Large contact surface for bidirectional traction.
- Selfcleaning properties due to tread pattern.

INDUSTRIAL: All-terrain - mixed surfaces



Continental

IC 30 - Diagonal

- Profile suited to use on unpaved surfaces.
- Solid shoulder with wearresistant rubber compound.
- Long service life. Selfcleaning profile for good traction.

INDUSTRIAL/CONSTRUCTION: Soft ground



Continental

IC 40 - Diagonal

- For use in harsh conditions.
- Extra Deep Profile: low hourly operating cost.
- Excellent tread pattern for good traction.
- Greater sidewall stability for enhanced shock resistance.

INDUSTRIAL: Mixed surfaces



Continental

MPT 81 - Radial

- Radial casing suitable for all-terrain trucks on paved or unpaved surfaces.
- Very good contact patch: tread pattern specifically designed for increased traction force.
- Durability.
- Very good hightraction mobility due to tread pattern.

INDUSTRIAL/CONSTRUCTION: All-terrain - mixed surfaces, snow



Continental

RT 20 - Radial

- Long service life.
- Good damage resistance, even in very difficult conditions.
- Maximum tilting stability.

INDUSTRIAL: Severe conditions



Continental

RV 20 - Radial

- Low energy consumption.
- Great damage resistance due to construction.
- Wet grip.

INDUSTRIAL: Hard surfaces

Advice

Each tyre is specific and homologated to a machine type. Contact your dealer to fit the homologated tyre with appropriate size and model for your machine. To prolong the service life of your tyres, inject our anti-puncture concentrate: see p. 55.



SKS Classic - Diagonal

Robust tyre made of natural rubber.

- High resistance to tears and punctures.
- Tread with deep lugs for better traction.
- Increased durability.

CONSTRUCTION: All-terrain - soft ground



SKS Hauler - Diagonal

Robust tyre made of natural rubber.

- High resistance to tears and punctures.
- Multilayer construction for highly robust sidewalls.
- Deep lugs for greater durability.
- Solid profile for enhanced grip in the harshest conditions. Long service life.

CONSTRUCTION: All-terrain - mixed surfaces



SP T9 MPT - Radial

For industrial, all-terrain and on-road applications.

- Compact central tread blocks for increased comfort and high stability on the road.
- Balanced distribution of lugs for even ground pressure distribution.
- Powerful traction and self-cleaning properties.
- High mileage potential.

INDUSTRIAL: All-terrain - hard floors



SP PG 7 - Radial

Nondirectional, for multipurpose industrial and construction applications.

- All surfaces.
- Good traction.
- Radial construction and flat tread profile for even ground pressure distribution.
- Self-cleaning properties.

INDUSTRIAL: All-terrain - mixed surfaces

Inflation:

Tyre pressure must be checked regularly and the manufacturer's instructions should always be followed (highway code). Tyre inflation pressure is responsible for the machine's stability, grip, comfort and performance. Over-inflation causes loss of comfort, wear on the center of the tread and reduced puncture resistance. Under-inflation, however, damages the tyre carcass by causing premature wear on the sidewalls, greatly increases fuel consumption and reduces driving accuracy. Tyre inflation should always be checked when tyres are cold.

Advice

Feel free to ask your MANITOU dealer for advice.



Manitou PNEUMATIC SHAPED SOLID TYRES

Pneumatic shaped solid (PSS) tyres can easily support heavy loads. They are an alternative replacement for pneumatic tyres, in some industrial or semi-industrial material-handling contexts on masted forklifts.

Their advantages

- Excellent stability and traction.
- Longer service life than pneumatic tyres.
- Enhanced security: no risk of punctures.
- High load capacity.
- Excellent thermal performance.
- Good resistance to cuts and tears.

Your MANITOU dealership has selected the best brands for you, with a wide choice of standard, non-marking and anti-static PSS tyres.

It's even easier and quicker to make use of the PSS service on your own site!

Your dealership can offer you a PSS fitting service, on-site or in the workshop. Record times and minimal downtime for your trucks.

A complete service:

- Removal of the pneumatic shaped solid tyres.
- Fitting of tyres.
- Take-back and recycling of your old tyres.

PSS Easy rapid fitting system

Allows rapid manual installation directly onto the machine.

Can be adapted to different types of wheel rims. The assembly press is not needed, as this system uses an adapter specifically designed for the purpose. This assembly process allows you to make savings, in terms of energy consumption, downtime and staff.

Complete wheels

MANITOU offers the option of ordering complete wheels, and at retail price: casing, wheel rims, etc. Please contact your dealership for advice.



Continental

CS 20

Strong technological innovation profile, with its double L tread:

- Excellent cornering stability while reducing vibrations.
- Superb handling.
- Very low rolling resistance.
- Low operating costs.

Available in CSEasy rapid fitting system.

Industrial - hard surfaces



Continental

CS EASY SC20

Innovative and economical:

- Low rolling resistance.
- Low heat development.
- Low energy consumption.
- Operating costs among the lowest on the market.

Easy fitting process: no need for assembly press.

Industrial - hard surfaces



Continental

SC 20 ENERGY +

Tyre specifically designed for machines with electric engines.

- Interior applications with low rolling resistance.
- Energysaving.
- Nonmarking version available.

Available in CSEasy rapid fitting system

Industrial - hard surfaces



Continental

SC 20 MILEAGE +

Optimized for diesel and gas machines.

- External applications, with low rolling resistance.
- Low operating cost: high hourly rate.
- Performance.
- Nonmarking version available.

Available in CSEasy rapid fitting system.

Industrial - hard surfaces



Continental

CSEasy rapid fitting system

Allows rapid manual installation directly onto the machine.

Can be adapted to different types of wheel rims. The assembly press is not needed, as this system uses an adapter specifically designed for the purpose. This assembly process allows you to make savings, in terms of energy consumption, downtime and staff.



Magnum

- Intensive use.
- Three-layer tyre for greater comfort and reduced temperatures.
- Tread with wide tread blocks for greater stability.
- Thicker outer tread layer.
- Low rolling resistance for reduced fuel consumption.
- Nonmarking version available.

Industrial - hard surfaces



Barum

Barum

High quality tyre for moderately intensive applications (1000h).

- Reinforced sidewall for extra protection. Central band of tread for greater linear stability.
- Unusual tread pattern for a comfortable drive and even wear.
- Excellent value for money.

Industrial - hard surfaces

Advice

For changing your tyres, take a look at our hydraulic jack, p.54.



Lifting Chains

Tyres, Chains & Hydraulic Components

Manitou LIFTING CHAINS

MANITOU offers a range of chains for lifting masts. Carefully selected from among the best manufacturers, our chains are all of superior quality: Long service life and high performance to match the diversity of your applications perfectly.

Performance and quality appreciated by users

Manitou has chosen chains that best meet your operational requirements. The criteria we use to ensure quality and safety are as follows:

- Wear and elongation resistance,
- Resistance to fatigue (progressive breaking of plates) and tensile strength (sudden breakage of plates or pins).
- Corrosion resistance.

Ranges: Series LH, series ASA

- Available in the specific dimensions of each mast and conform to ISO 434, French standard NF-E - 26 -107 and American standard B29.8.
- Poor maintenance of lifting chains causes premature wear. Lubrication and regular checking of chains are essential to ensure proper functioning and prolong service life. Refer to Servicing & Maintenance chapter to find out about the special chain lubricant.
- The regulations require chains to be replaced at 3% elongation, in other words if the chain is 3% longer than its original length.
- Specific chains lubricants and greases have been developed by Manitou. See chapter Service and maintenance.



Chain wear gauge

For each pitch checked, the ruler indicates the number of links identified and allows you to assess the elongation of the chain. For use on leaf chains with 12.7 mm to 44.45 mm pitch.

161583

Hydraulic and Wearing Components

Tyres, Chains & Hydraulic Components



Quick-connect hydraulic couplings

These hydraulic couplings have valves that allow rapid connection.

Quick release coupling male	266089
Quick release coupling female	266090
Plastic plug	261398
Plug female	192039
Hydraulic connector	192040

Quick release coupling male	62843
Quick release coupling female	62844
Plug female	1788
Quick release coupling male	30978
Quick release coupling female	30977
Quick release coupling male	33753
Quick release coupling female	33754



Quick-connect hydraulic couplings

- For high flow gas pipe Ø 21 X 17 mm 3/4 BSP (gas).

These hydraulic quick couplings adapt to take the place of the original connectors. Their capacity to absorb large flow rates allows sizable hydraulic attachments to be accommodated.

Hydraulic coupling female	581794
Hydraulic coupling male	581795

Advice

Check the parts assembled are clean to avoid contamination into your hydraulic system.



Anti-pollution hydraulic rapid couplings

Pipe thread Ø 21 mm / 3/4 BSP (gas).

Connection size particularly used for agricultural machine attachments.

Hydraulic coupling female	582371
Hydraulic coupling male	582372



Anti-pollution hydraulic rapid couplings

Pipe thread Ø 24 mm / 1/2 BSP (gas).

Connection size particularly used for attachments such as mixer buckets.

Hydraulic coupling female	264144
Hydraulic coupling male	261397

Advice

Feel free to ask your MANITOU dealer for advice.



Coupler plate kit

Rapid lever locking and unlocking system using hydraulic attachments.

- High quality materials to extend the service life of the kit: Zinc and nickel couplings and levers, stainless steel nuts and aluminum plate.
- Reduced loss of hydraulic head pressure maintaining a nominal rate of 45L/min for a maximum rate of 90L/min.
- Max working pressure: 330 Bars.

Specifically for MLT 634 / MLT 735.	895886
Protector for moving coupler on attachment	895973
Moving coupler for attachment	895887
Protector for fixed coupler on machine	895972



Quick coupler kit Ø 16 mm

Consists of a quick release coupling male, a quick release coupling female, a female plug, and a connection.

662272



Hydraulic decompression kit

Assists opening of hydraulic couplings for the connection of attachments.

252260



Easy connect system (ECS)

Operating principle:

- Changing attachments is a repetitive and tedious procedure: while the residual pressure in the system is not released, it is easy to disconnect, but impossible to reconnect a tool.
- Thanks to the ECS, the driver gets out of the machine with the engine running and stands level with the attachment carrier. After activating the protected control and using the independent solenoid valves directed to return to the tank, the driver releases the pressure of the hydraulic circuit of the attachments. The Hydraulic couplings can then be disconnected and a new attachment connected.

Customer benefits:

- Saves time... the operator can reduce hydraulic pressure with just one click of the accessory line.
- Rapid change of attachments.
- Increased safety... the operator eliminates the risk of injury and oil discharge during the procedure.
- Increased profitability... service life of couplings is prolonged, hydraulic pollution is reduced and the starter is saved from wear, as the operator does not have to stop the engine.
- Numerous models available in the MANITOU range. Your dealer will advise you on the kit most suitable for your machine model.



Hydraulic locks for attachments on the TS with quick couplings

Easy to use, allows a hydraulic attachment to be connected to a simple carrier and quick movement from one attachment to another.

List of the appropriate model to your machine type : see your Manitou dealer.



Mach II connector

- Connects two hydraulic lines with a simple tilt of a lever and rapidly connects a hydraulic attachment.
- Protects couplings from dust and shocks.
- Secures the hydraulic connection.

Contact your dealer to know the available part for your machine type.



Attachment connector

661796



Toothed V-belt

Double fan belt for Perkins 1004T engine.

563270



Flat belt - 8 ridges

Alternator belt for John Deere 4045 engines (St3B and St4).

796760



Toothed V-belt

Alternator belt for Perkins 1104D engine.

291467

Advice

Recommendation: Consult your dealer for advice on the correct belt for your engine.





**SIGNAL, VISIBILITY
& ELECTRICAL
ACCESSORIES**

Batteries	66
Electrical components	68
Switches & Key switches	70
Rear lights	72
Front lights	74
Working lights	76
Beacons	78
Lights & Horns	79
Lamps & Bulbs	80





Batteries

Signal, Visibility & Electrical Accessories

Manitou **BATTERIES**

On the work site, your MANITOU truck suffers from various external pressures and stresses. Shocks, vibrations, bad weather and climate changes should not hinder repeated starting. This is why MANITOU is rigorous in the selection of its battery models. Their high performance ensures that your daily work goes smoothly.

Great reliability, optimal power, long service life, and so on. Benefit from the latest technological advances with MANITOU 12 volt batteries.

Our starting batteries for professional or personal use are guaranteed:

- Maintenance-free.
- 24 months.
- Ready to use.
- Clean and easy to handle!

Technical advantages

- Insulated unbreakable thermoplastic housing, resistant to acids, battery gases and diluted bases.
- Anti-oxidation treated silver plated copper alloy auxiliary contacts. Crimp or welded connection.
- Contacts attached by insulated central screw, easy replacement.
- Maximum voltage of standard use: 150 volts.
- Temperature: -20° to +90°.
- Standard wiring.
- Fool proof system for various voltage ratings.
- Insulated unbreakable thermoplastic housing, resistant to acids, battery gases and diluted bases.
- Anti-oxidation treated silver plated copper alloy auxiliary contacts. Crimp or welded connection.
- Contacts attached by insulated central screw, easy replacement.
- Maximum voltage of standard use: 150 volts.
- Temperature: -20° to +90°.
- Standard wiring.
- Fool proof system for various voltage ratings.

Advice

A complete range of starting batteries is available from your dealer. Ask your Manitou-approved professional for advice.



MANITOU range

High power for reliable startup in cold weather. Resistance to difficult conditions (vibrations, shocks, etc.).

Optimum endurance and durability for intensive use.

Technology:

- Thick plates.
- High-precision short circuit resistant pocket-separators.
- Anti-vibration resin bands.
- Product conforms to Class II, EN Standard approved for your machine.
- Other models available, consult your dealer.

12 V	43 Ah / 370 A	207 X 175 X 175	745149
12 V	44 Ah / 360 A	207 X 175 X 190	609940
12 V	45 Ah / 330 A	219 X 134 X 223	419749
12 V	62 Ah / 540 A	242 X 175 X 190	80147
12 V	70 Ah / 540 A	269 X 175 X 222	505538
12 V	74 Ah / 680 A	278 X 175 X 190	546190
12 V	74 Ah / 680 A	278 X 175 X 190	275727
12 V	95 Ah / 680 A	306 X 173 X 222	485215

12 V	105 Ah / 850 A	315 X 175 X 205	689092
12 V	110 Ah / 750 A	348 X 175 X 232	247068
12 V	110 Ah / 900 A	348 X 175 X 235	282080
12 V	140 Ah / 900 A	508 X 175 X 205	744370
12 V	145 Ah / 1000 A	360 X 253 X 240	745150
12 V	155 Ah / 900 A	510 X 218 X 225	718562
12 V	180 Ah / 1000 A	510 X 223 X 223	283831
12 V	180 Ah / 1235 A	513 X 223 X 223	303985



Battery charger

Battery charger designed for lead batteries with a capacity of 1.2 to 120 Ah. Can be used to charge a battery connected to the vehicle or not.

- Connection cable kit with clips (supplied).
- Certified safe for onboard electronics, with automatic cut-off at end of charge.

For 1.2 to 120 Ah batteries	161 X 61 X 38	720360
-----------------------------	---------------	---------------



Traction battery

Traction battery for the power requirements of work platforms, industrial forklifts and warehouse equipment. Intensive use. Reliable and durable.

- Operating period: 3500 cycles, approx. 4 to 5 years.
- Ultra-rapid charging.
- Low maintenance, water consumption up to 70% less than conventional batteries.
- Increased power availability.
- Other models available according to machine type. Ask your dealer for advice.

Advice

Safe use: To avoid connecting batteries with incompatible chargers or different voltages, each housing has a corresponding colour and key.

Electrical components

Signal, Visibility & Electrical Accessories



Battery connector 80 amp

Cross section 16 mm².

Male connector black	80 A	490394
Female connector black	80 A	490393
Handle		582458



Battery connector 160 amp

Cross section 35 mm².

Male connector black	160 A	947981
Female connector black (integral handle)	160 A	947980



Battery connector 320 amp

Cross section 70 mm².

Male connector black	320 A	947982
Female connector black	320 A	947983
Handle		486356



Battery connector 160 amp

With two auxiliary contacts.
Cross section 50 mm².

Connector gray	160 A	419560
Handle		418601T



Battery connector 175 amp

Cross section 50 mm².

Connector gray	175 A	5618T
Connector red	175 A	473010
Handle		418601T



Battery connector 350 amp

Cross section 50 mm².

Connector gray	350 A	419491
Handle		418601T

Advice

Bipolar connectors: heavyduty polycarbonate onepiece molding.
The two parts are identical, doing away with concept of male/female.

Advice

Circuit-breaker: Prevents untimely discharge of your battery. Makes theft more difficult. Protects from interventions on the electrical circuit and protects the system during soldering work.

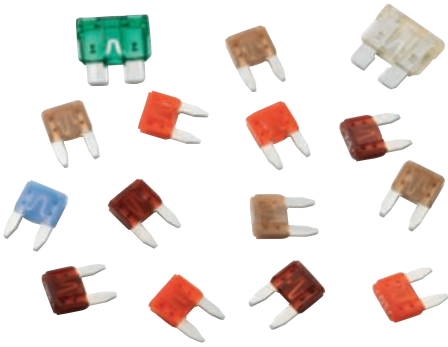

Set of 15 mini fuses

- 5 A beige: 4 pcs
- 7.5 A brown: 4 pcs
- 10 A red: 4 pcs
- 15 A blue: 1 pcs
- 25 A white: 1 pcs
- 30 A green: 1 pcs

720134



Circuit-breaker

Control with fixed cut-off handle.

- 2 copper terminals.
- Fixed cut-off handle.
- Voltage up to 48 V. 150 A.
- IP 54.

518230



Circuit-breaker

- 2/24 V - 100A max.
- Metal screw terminals
- M10.Red key - Removable in stop position.
- External diameter 57 mm / Mounting centre: 38 mm.
- Comes with nut and connecting washer.
- Insulation conforms to DIN 40050: IPX2 rear, IPX4 front.

Circuit-breaker

223594

Replacement circuit-breaker key

485107

Advice

Battery terminals: Clamp model, which allows the lug to be disconnected from the battery terminal without removing the connecting cable. Suitable for cables with cross-sections of 40 mm² or 60 mm². Bronze battery terminals.



Terminals

Device suitable for diesel and gasoline engines.

Positive +

485223

Negative -

485224



Terminals

Pair.

Suitable for diesel and gasoline engines.

Includes: 1 positive terminal (+) and 1 negative terminal (-)

485242



Valve type battery terminal

Device suitable for diesel and gasoline engines.

Negative - (green)

239478

Positive + (red)

239479

Manitou ALTERNATORS AND STARTERS

The alternator is a continuous voltage generator driven by the thermal engine, via a belt. It recharges the battery and powers the electrical system of your machine. MANITOU alternators are 100% guaranteed genuine parts. They are tested and qualified to give you maximum performance and service life while reducing your motor's fuel consumption.

The starter is an auxiliary electric, which rotates the thermal engine during the start up phase. The robustness and resistance to repeated start-ups of MANITOU starters ensure that your motor will start in all kinds of weather.

Check your belt when servicing your MANITOU to prevent deterioration of engine parts, which could result in a breakage.

Your MANITOU machine's performance depends on a delicate balance of all its constituent parts. To ensure the best quality and reliability of our products, we have carefully selected parts that meet a strict set of criteria.

Choosing MANITOU parts is a guarantee of maximizing the performance of your machine.

Whatever the model or age of your MANITOU forklift truck...

- **You are sure to find the model that matches your machine at your dealership.**
- **Your dealer will be happy to advise you in your choice.**

Switches & Key switches

Signal, Visibility & Electrical Accessories

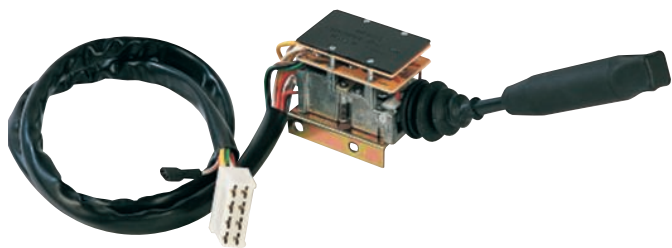

Switches and controls

For headlamps and direction indicators or windshield wipers.
Various wiring harness lengths.

With push button control for lighting and warning buzzer in all positions.	162841
Light switch Wiring harness length: 1100 mm	191384
Light switch Wiring harness length: 500 mm	233919

Windshield wiper control Wiring harness length: 500 mm	265798
Light switch for MRT Wiring harness length: 1000 mm	569473



Reverse switches

This unique model is the ultimate universal product.
Very reliable and robust, it is suitable for the whole MANITOU range.

Power-operated reverse switch 12 V	234956
------------------------------------	---------------



Key switches

Reliable and robust.
Smooth action.
Very good finish.
Come with a set of two keys and six electrical plugs.

With folding hood	184817
MANITOU ignition key	184818
Key switch for VJR work platform	745357
Spare key	70149
Stainless steel key switch for ATJ work platforms	703640
Spare key	58863

Advice

Using spare parts or attachments that do not conform to original specifications can result in some nasty surprises... Even though they may seem to fit your machine's requirements, they often have a shorter service life and perform differently to the original parts. In some cases, you run the risk of breakage.

Rear lights

Signal, Visibility & Electrical Accessories



Adjustable signal rack

- Delivered wired, assembled and ready for use.
- Galvanized tube 30 x 10 mm.
- 2 lights with bulbs (12 volts).
- Stopping and indicator lights.
- 2 reflective triangles mounted on stand.
- 1 power cable 7.50 m with 5 conductors (fitted with plastic 7 pin plug).
- 2 adjustable fixing brackets (with nuts).
- Extensible and adjustable.
- Adjusting the width.
- Min: 1 m. Max 1.60 m, having 6 holes placed every 10 cm.
- Driving regulations: mandatory for trailers or towed devices.

490190



Magnetic signaling kit

- Stopping lights and change of direction lights.
- For use on all types of vehicle or towed equipment.
- Rapid attachment using magnetic device.
- Allows good signaling.
- 2 round magnetic studs, Ø 80 mm screwed to support.
- Fitted with 2 lights supplied with bulbs.
- Breakproof cover.
- 7 metre connection cable.

545973



Trailer socket

Female socket metal	166347
Male socket plastic	18992



Electric socket mount

Fixed to the back of the vehicle, this mount allows easy installation of a female trailer socket.

206047

Advice

MANITOU is in constant contact with its suppliers to provide you with the most suitable products, the best choice and quality at very competitive prices. Ask your dealer for advice

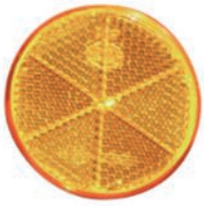

Yellow side reflector (TÜV)

194512

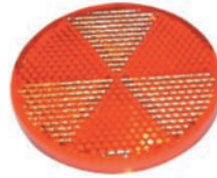

Red back reflector (TÜV)

184964



Rear light

MCE, MCL, MC...CP, M2, M4

- Dimensions: 160 X 60 X 50 mm
- 3 functions: parking, stop and flashing
- Operates with bulb (not supplied) :
12 V - 5 W (Ref. 163 825)
12 V - 21 W (Ref. 675)

Right rear	163783
Left rear	163782



Standard light

- Right or left.
- Dimensions: 145 X 105 X 60 mm
- 3 functions: parking, stop and flashing
- With license plate light.
- Operates with bulbs (not supplied):
12 V - 21 W (Ref. 675),
12 V - 5 W (Ref. 163825)

894814



Rear light MRT 1850

- Dimensions: 190 X 105 X 60 mm
- 5 functions: stop, parking, flashing, reverse and plate light.
- Operates with bulb (not supplied):
12 V - 5 W bulb (Ref. 163 825),
12 V - 21 W bulb (Ref. 675)

Right rear	587421
Left rear	587422



Independent reverse light

- Dimensions: 80 x 120 x 55 mm.
- Operates with bulb (not supplied):
12 V - 21 W (Ref. 675).

236148



Special blue headlight for poultry sector

- Diffuse light for working in the poultry sector.
- Blue light.

734154



PRIVILEGE Rear light

- Dimensions 225 x 122 x 73 mm.

Right - includes reversing light (white)	259356
Left	259357

Advice

All tail lights are delivered without bulb. Consider ordering the appropriate bulb (refer to information leaflet).

Rear lights

Signal, Visibility & Electrical Accessories



Front headlight for Manitou MLT / MT machine

- Optical lens for wide beam, long range light.
- Housing and rim in glass fibre reinforced black material.
- Dimensions: 90 x 150 mm.
- Operates with bulb (not supplied): H3 12 V - 55 W (Ref. 164 378)

Front right and rear left machine light	223595
Front left and rear right machine light	223596



Light with protective gate

Light secured by a protective steel gate.

Front right	197475
Front left	197476



MLT / MT front light

- Front light with integrated indicator.
- Operates with bulbs (not supplied):
H3 12 V - 55 W (Ref. 164378)
12 V - 2 W (Ref. 20996)
H7 12 V - 55 W (Ref. 563881)
12 V - P21 W (Ref. 563882).

Front right	Right-hand drive	224580
Front left		224581
Front right	Left-hand drive	224582
Front left		224583



Front light for Manitou MLT / MT 14-18 m machines

Front right	Right-hand drive	265415
Front left	Left-hand drive	265416

Advice

Don't hesitate to ask your MANITOU dealer for advice.





Working lights

Signal, Visibility & Electrical Accessories

Manitou WORK LIGHTS

To ensure that you can carry out your work in the best conditions, we have chosen a range of models that offer wide and uniform illumination.

For greater security and comfort. Optimized light intensity makes it possible to carry out work at dusk or in total darkness, **which means more cost efficiency and less fatigue for your organization!**

Xenon work light technology:

Optimal efficiency:

- **Xenon work lights** have a stronger light intensity.
- Illumination is more even and closer to daylight.
- They illuminate **three times more than conventional floodlights**.

Guaranteed savings:

- **Lower energy consumption:** Xenon technology gives you a higher luminous flux than a standard bulb using less power. Light appears immediately after turning on the lights.
- **Longer service life:** the lifetime of your lights is longer than that of standard floodlights.



Classic round floodlight

- Tilts and swivels in all directions
- Back power switch.
- With handle and rotary switch to provide a better seal.
- Antishock grille and glass lens. 2point mounting bracket.
- Operates with bulb (not supplied):
12 V - 40/45 W (Ref. 32058)
H3 12 V - 55 W (Ref. 164378)
H3 24 V - 70 W (Ref. 485235)
- Size: Ø 150 mm.

874



Cabin floodlight

- No power switch or handle.
- Mineral glass lens highly resistant to shocks.
- Fixing screw Ø 10.
- Operates with bulbs (not supplied):
12 V (Ref. 164378)
24 V (Ref. 485235).
- Dimensions 90 X 150 mm.

223480



Halogen work light

- Proximity lighting.
- Plastic box with glass fibre reinforced.
- Glass lens.
- IP67: resistant to highpressure washing.

right	265419
-------	--------

left	265420
------	--------



LED work light

- Low energy consumption 12W, dualvoltage 1030V, 1500 Lumens.
- Service life more than 30,000 hours.
- Mineralized techno resin body. Attachment Ø 10 for mounting.
- IP67 (resistant to hydrojet highpressure washing).
- Dimensions 120 X 90 mm.

947997



LED work light

- Energy consumption 25 W, dualvoltage 12/24V, 1500 Lumens.
- Service life more than 30,000 hours.
- Aluminum body.
- Attachment Ø 10 for mounting.
- IP67 (resistant to highpressure washing).
- Dimensions 1530 X 130 mm.

52502273



Xenon work light

- 4th generation of Xenon.
- Ballast integrated.
- Weak consumption.
- Very long lifespan.
- Dimensions: 100 X 160 x 120 mm.
- Available in 12V.

788305

Beacons

Signal, Visibility & Electrical Accessories



Rotating LED beacon light

- 5 high power LEDs.
- 12 / 30 volts.IP69K.
- EU approved ECE R10.
- Long service life up to 30,000 hours.

Rotating LED beacon light with flat base, for mounting	958826
Rotating LED beacon light with flat base, magnetic version	958827



Rotating beacon light 12/24 V SSW

- Operates with bulb (not supplied) 12 V or 24 V.
- Orange or red lens.
- Optional: magnetic mounting kit.

Orange rotating beacon light	466246
Orange replacement lens	470003
Magnetic mounting kit	470002
Bulb H1 12 V-55 W	466247
Bulb H1 24 V-70 W	466248



Rotating beacon light

- Rotating beacon light 12 V.
- Operates with light (supplied) H1 (Ref. 466247).
- Direct drive of rotation by bevel gear.
- Pin mounted.

Rotating beacon light	224759
Replacement lens	661502



Rotating beacon light flexible ball

- Rotating beacon light 12 V.
- Orange unbreakable polycarbonate lens.
- Flexible robust base.
- Operates with bulb (supplied) H1 (Ref. 466 247).

Rotating beacon light	895507
Replacement lens	719893



Rotating light for MRT series

- Operates with bulb (not supplied) H1 12 V 55W.

Orange rotating beacon light	543513
Red rotating light	672119
Red replacement lens	672305
Bulb H1 12 V-55 W	466247



Ellipse rotating light

- Magnetic base.
- Energy saving (60%).
- Innovative design and technology.
- Compact size.
- Best value for money.

Magnetic	788169
----------	---------------



Economical rotating beacon with magnetic mounting

- Compact posable rotating light.
- Operates with bulb H1 (Ref. 466247) supplied.
- Orange colour.

Rotating beacon light with magnetic mounting	554935
Bulb 12V	466247

Lights & Horns

Signal, Visibility & Electrical Accessories

Advice

Safety: Reversing a bulky vehicle is synonymous with poor visibility and can be dangerous. An audible reversing alarm is one way of improving the safety of your maneuvers.



Independent indicator light

For MT

- Dimensions: 90 x 60 x 55 mm.
- Operates with bulb (not supplied): 12 V - 21 W (Ref. 675).

Right	551322
Left	551814



Standard round indicator light

- Dimensions : Ø 75 mm.
- Depth 50 mm.
- Operates with bulb (not supplied): 12 V - 21 W (Ref. 675)

Base	296523
Lens	296524



Flashing light

To provide better safety in fog.

- High brightness 360° flash.
- Orange lens.
- Flat mounting with screw.

With bulb 12 to 80 V. With lens Ø 80 mm.	554947
With bulb 12 to 80 V - 2 W Lens Ø 100 mm	573389



Electronic reversing alarm with loudspeaker

- Original part for construction machines.
- No delay
- Voltage: 12 to 24 V
- Sound level (2m): 91 dB minimum.
- Temperature range -40°C to +85°C.
- Consumption: 6 A.

76925



Vehicle horn

- Voltage: 12 V.
- Sound level (2m): 107 dB minimum.
- Frequency 410 Hz.
- Temperature range -40°C to +85°C.
- Consumption: 5.5 A.

20125



Buzzer

- Voltage: 12 V.
- Sound level (25 cm) : 65 dB.
- Temperature range -40°C to +85°C.
- Consumption: 1.5 milliamperes.

176737

Lamps & Bulbs

Signal, Visibility & Electrical Accessories



Bulb Code / Light EC (white)

Bulb 12V - 45/40W	32058
Bulb 24V - 55/50W	5852T



Bulb pear single filament (sold in pack of 2)

Bulb 12V - 21W	675
----------------	------------



Halogen bulb H1

Bulb H1 12V - 55W	466247
Bulb H1 24V - 70W	466248



Halogen bulb H3

Bulb H3 12V - 55W	164378
Bulb H3 24V - 70W	485235
Bulb H3 48V - 60W	69-819



Halogen bulb H4 and H7

Bulb H4 12V - 55/60W	489668
Bulb H7 12V - 55W	563881



Bulb pear double filament

Bulb 12V - 21/5W	31867
------------------	--------------

Advice

Please also see p. 94, for our personnel safety equipment.

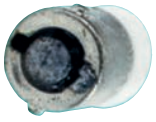

Warning light bulb

Warning light bulb 12V - 1.2W	170836
Warning light bulb 12V - 3W	474784
Warning light bulb 12V - 4W	20996
Warning light bulb 24V - 4W	111727



Festoon bulb

Festoon bulb 12V - 5W	676
Festoon bulb 12V - 10W	746490
Festoon bulb 12V - 18W	172995



Sidelight bulb

Sidelight bulb 12V - 5W	163825
Sidelight bulb 12V - 10W	179413



Bulb box

Contents :

- H7 halogen lamp
- H3 halogen lamp
- 12V21W single filament bayonet lamp
- 12V5W tubular lamp
- 12V10W single filament round lamp
- 12VPY21W front indicator bulb
- 12V1.2W bayonet lamp
- 3 mini fuses (7.5, 10, 15 A)
- 3 ATO fuses (7.5, 10, 15 A)

959200







Driver seats	84
Seats & Seat Covers	86
Seatbelts	87
Sound system	88
Driving comfort	89
Geolocalization & anti-theft protection	91
Safety	92
Peripherals Components	94
Wiper blades	96
Rear-view mirror	97

Driver seats

Comfort, Cabin & Safety

Advice

When work comfort is synonymous with health ... Due to vibrations and physical shock, your working conditions are often reasons of back pain. Fortunately there are preventative solutions tailored to your body and your current activities. MANITOU offers you seats that are ergonomically designed to ensure your physical well-being and protect your health. Guaranteed comfort and a healthy back. The selection of seats from MANITOU ranges from simple to more sophisticated so that they are the perfect fit for all machines, all requirements and all budgets: from the economy version to versions with mechanical suspension, or air, ending with the low-frequency version (progressive amortization) for optimal comfort.



For industrial forklifts

Economic range

- Built in suspension
- Reclining backrest
- Safety belt
- Presence sensor
- Waterproof and durable cover
- Very ergonomic
- Guaranteed comfort
- Microaerated cushion
- Longitudinal adjustment: 150 mm
- Weight adjustment: 50 - 120 kg

Upholstery: black leatherette

720630



For industrial forklifts

Comfort range

- Automatic seat belt
- Presence sensor
- Adjustable backrest
- Mechanical suspension with dust cover
- Ergonomic handles to allow the operator to easily climb onto the forklift
- Spacing guides: 328 mm

Upholstery: black leatherette

787449



For industrial forklifts

Comfort range +

- Air suspension with 12 V electric compressor
- Height adjustable
- Reclining backrest
- Safety belt
- Practical: integrated document holder in backrest
- Longitudinal adjustment: 210 mm
- Weight adjustment: 60 - 130 kg

Upholstery: black leatherette

661853



MB / MC / 4RM / 4RE / MT range

Economic range

- Suspension located behind the backrest
- Safety belt
- Longitudinal adjustment: 150 mm
- Weight adjustment: 50 - 130 kg

Upholstery: black leatherette

554911



MSI/MC range

Comfort range

- Fits all industrial forklifts Integrated suspension
- Reclining backrest
- Safety belt included
- Spacing 180 mm
- Longitudinal adjustment: 195 mm
- Weight adjustment: 50 - 120 kg

Upholstery: leatherette with sensor

52532165

Upholstery: fabric with sensor

52532166



MSI/MC range

Comfort range +

- Air suspension with 12 V compressor
- Reclining backrest
- Height adjustable
- Safety belt
- Presence sensor
- Longitudinal adjustment: 160 mm
- Weight adjustment: 50 - 133 kg

Upholstery: fabric

253001



MI range

Comfort range ++

- Mechanical suspension.
- Very thin profile.
- Suspension travel from 60 to 80 mm
- Weight adjustment range 50/170 kg
- Rear adjustment: adapts to all sizes
- Lumbar support for optimal comfort
- Swivel from side to side in 10° increments
- Retractable safety belt
- Document storage box
- Rear insulator against horizontal vibrations and jolts
- Operator presence switch
- Seat heater
- For details ask your dealer for brochure 8AA1220 (seat 898480).

Upholstery: leatherette	52502492
Fabric cover	947164



MLT/ MC/ M/ MT range

Economic range

- Integrated suspension
- Reclining backrest
- Height adjustable
- Safety belt
- Presence sensor
- Longitudinal adjustment: 150 mm
- Weight adjustment: 60 - 130 kg

Upholstery: black leatherette	314253
Backrest	941307
Cushion	941308



MLT/MT range

Comfort range

- Mechanical suspension
- Reclining backrest
- Height adjustable
- Lumbar support
- Safety belt
- Presence sensor
- Longitudinal adjustment: 110 mm
- Weight adjustment: 50 - 130 kg

Upholstery: fabric with MANITOU logo	252758
Upholstery: leatherette	253000
Fabric cover with MANITOU logo	947164



MLT/MT range

Comfort range +

- Integrated suspension
- Reclining backrest
- Height adjustable
- Included safety belt
- Included presence sensor
- Longitudinal adjustment: 160 mm
- Weight adjustment: 50 - 120 kg

Upholstery: fabric with MANITOU logo	253004
Armrests kit	582669
Fabric cover	947224



MLT/MT range

Comfort range +

- Air suspension with 12 V compressor
- Reclining backrest
- Height adjustable
- Lumbar support
- Safety belt
- Presence sensor
- Longitudinal adjustment: 150 mm
- Weight adjustment: 50 - 130 kg

Upholstery: fabric with MANITOU logo	958694
Fabric cover	947164



MLT/MT range

Comfort range ++

- Air suspension with 12 V compressor, low frequency
- Reclining backrest
- Air adjustable height from 60 mm
- Retractable safety belt, left side
- Presence sensor
- Longitudinal adjustment 140 mm
- Automatic weight adjustment: 50 kg - 130 kg.
- Longitudinal horizontal suspension
- Mechanical lumbar support
- Backrest extension included
- Document compartment (net)

Upholstery: grey and black matrix fabric	959168
--	---------------

Advice

Feel free to ask your MANITOU dealer for advice.

Seats & Seat Covers

Comfort, Cabin & Safety



MLT/MT range

Comfort range ++

- Professional seat.
- Air suspension with 12 V compressor
- Reclining backrest
- Height adjustable
- Height adjustable headrest
- Adjustable armrest
- Retractable safety belt
- Presence sensor
- Longitudinal adjustment: 130 mm
- Weight adjustment: 50 - 120 kg

Upholstery: fabric with MANITOU logo	302227
--------------------------------------	---------------



MRT range with 2 joysticks

Specific range

- Included support for 2 joysticks
- Integrated suspension
- Reclining backrest
- Height adjustable
- Safety belt
- Presence sensor
- Longitudinal adjustment: 160 mm, base: 200 mm
- Weight adjustment: 50 - 130 kg

Upholstery: fabric with MANITOU logo	739169
Headrest	743901



Seat cover

For seats 187922 and 486491	MT845 / MT940 / ML632	947225
For seats 252758, 958694, 958695, 253000 and 304841.	MLT523 / 634 / 735 / MT1840A / 1440A	947164
For seat 253004	MLT845 / MT1440 / MT1840 / MRT Easy	947224
For seat MRT 739169	MRT Privilege	947166
For seats 302226 / 302227 / 314253	MLT634 / 735 / 840 / 845 / 1035	947165

Customizable cover available in option. Contact your dealer.



Special cover for truck mounted forklifts

Special TMT

574246

Seatbelts

Comfort, Cabin & Safety



Belt with retractor

561722



Belt with retractor

947735



Belt with retractor and sensor

787897



Safety belt without retractor

207300



Safety belt fastening bar

564850

Advice

Legislation: Since 5 December 1998, European user directive No.95/63/EC specifies that an operator restraint system (safety belt) is required on all forklifts in service. For other countries, apply local regulation.

Sound system

Comfort, Cabin & Safety



Car radio FM-AM RDS

RDS FM/AM tuner, 30 presets, 4 x 50 W, 5 music presets, auxiliary input, USB port, red display and Manitou logo.

264353 BIS



CD MP3 car radio

CD / WMA / MP3 player, RDS FM / AM tuner, 30 presets, 4 x 50 W, 5 music presets, auxiliary input, USB port.

264354 BIS



CD BLUETOOTH MP3 car radio

CD / MP3 / WMA player, BLUETOOTH, RDS FM / AM tuner, 30 presets, 4 x 50 W, 5 music presets, auxiliary input, USB port.

304816



Two way speakers

70 W power, 2 recessed channels in a 100 mm diameter hole, 42 mm thick.

Frequency range of 90 to 20 000 Hz, dB/W/m sensitivity: 90 dB, impedance: 4 ohms.

243570



Dual cone speakers

70 W power, 1 channel, 100 mm builtin diameter hole, 42mm thick; frequency range of 90 to 18 000 Hz, dB/W/m sensitivity: 89 dB, impedance: 4 ohms.

719761

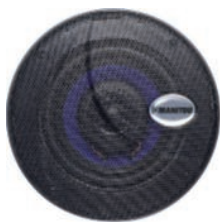

Two way speakers

70 W power (20 W nominal), polypropylene cone, aluminum coil, 100 mm diameter, 90 dB sensitivity, supplied with rack and connectors.

261331



Radio antenna

Universal 75 ohms antenna, unbreakable homogeneous rubber protection, solid and maintenance free, ready to install, comes with cable, roof fastenings.

243571



Electric cable

CD/mp3 car radio IPOD cable

787841

Advice

Equip your truck... We have selected a number of different car radio models and sound attachments. Reliable and efficient, they will accompany you all day long at work.



Driving comfort

Comfort, Cabin & Safety

Steering wheel knob



Easy grip.

- Fits most steering wheels.
- Attaches to one of the steering wheel spokes.
- Bi-colour knob made from Bakelite, stamped metal bracket with 2 fastening holes.

400160



Plastic steering wheel knob with fastening screw.

191358



- Plastic steering wheel knob with 12 diameter fastening thread.
- Very good grip of the handle.

252216



Plastic steering wheel knob with fastening screw.

746362

Gear knob

with transmission cutting-off button



211278

Locking door



600942

Splash guard

Complementing the mudguards, this attachment will protect your truck from splashes.

For more details and machine compatibility, contact your Manitou dealer.



Document storage box

Protects documents in your truck from the weather.

420774





Windscreen sunshade

For forklift truck type M - MC	199153
For truck type MT 8/17 m	242174
For truck type MLT	600733
For MRT truck	603291
For MVT and MHT trucks	587032



Sun visor on roof window

For forklift truck type M - MC - MT 8/17 m	211524
For truck type MLT	600730



Non-slip carpet

For forklift truck Dimensions: 150 x 1000 mm	171589
For the MRT truck fenders Dimensions: 850 x 500 mm	672867
For platforms Dimensions: 152 x 2250 mm	595400



Foot board

Adjustable on the M/MC ranges.

241740

Colour rear-view camera kit



- A high definition colour rear view system for improving safety during reversing maneuvers. This kit will turn on automatically when the reverse gear is engaged or stays on permanently.
- High image quality.
- Very good seal: resistant to dust and repeated high pressure washing. IP68 standard: dustproof and protection against prolonged immersion and specified liquid pressure.
- IP69K standard: 100% dustproof and protected against any water infiltration from highpressure washing systems (steam at around 100 bar).
- Applications: Road / TP / Agriculture

Colour LCD 5	Rear-view camera kit, consisting of: <ul style="list-style-type: none"> • 1 x 5 colour monitor with speakers, 2 camera inputs, resistance to 5G shocks. • 1 rear-view camera, 110° viewing angle, LED infrared night vision, resistance to 10G shocks. • IP68 sealing. 	958312
Colour LCD 7	Rear-view camera kit, consisting of: <ul style="list-style-type: none"> • 1 x 7 colour monitor with speakers, 2 camera inputs, resistance to 8G shocks. • 1 rear-view camera, 130° viewing angle, LED infrared night vision, resistance to 10G shocks. • IP69K sealing. 	958326

Geolocalization & anti-theft protection

Comfort, Cabin & Safety



EASY MANAGER

Looking for a solution to manage, optimize and secure your equipment?

EASY MANAGER is a simple and flexible tool for optimizing operational monitoring of your machinery regardless of the industry.

EASY MANAGER offers you:

- Realtime management of the condition and position of your machinery,
- Simple and optimized control of your activities and monitoring of maintenance,
- Functions to control and secure the use of the equipment, manage access permissions.

Combined with a maintenance contract, EASY MANAGER allows you to plan the technical monitoring of your fleet with your MANITOU dealer and to anticipate the immobilization of your equipment.

OUTDOOR: Fleet management and geolocation

INDOOR: Fleet management

ACCESS: Geolocation fleet management and access control with card and/or code.

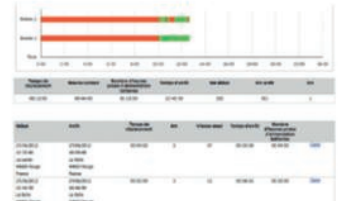
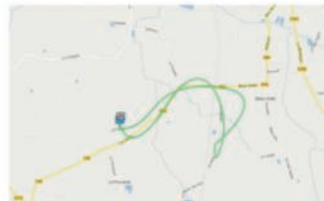

Securilock

- Deterrent which helps you effectively combat theft or damage due to machine downtime.
- Comes with 3 numbered keys (10 000 possible combinations).
- High performance cylinder.

676033



Eole anemometer

Displays the current speed, records the average and maximum speed. Displays a visual graphic. A thread on the device allows it to be mounted on a stand.

720293



Explorer anemometer

- Instantly shows wind speed in km/h, m/s, mph and knots.
- Stores the maximum wind gust.
- Waterproof and shockproof case.
- Screen with back light.

720292



Emergency hammer

To ensure your safety in case of emergency! Mandatory for approved "tractor" machines.

Emergency hammer	600996
Hammer mount	600982
Safety wire	600994



Fire extinguisher

Approved for all fires, maintenance free, 1 year service life.

1 kg fire extinguisher with mount.	505504
2 kg fire extinguisher with mount.	945412

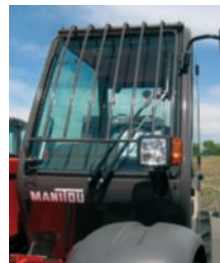

Protection grill on windscreen

Protects against falling objects and heavy loads.

Specific model for each machine type. Contact your dealer to fit your need.

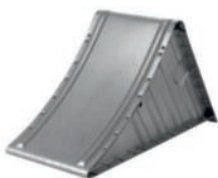

Triangle wheel wedge

Allows you to block the wheels of your truck and to immobilize it while stopped.

216070



Hardhat

575742

Advice

Safety: At certain heights, wind speeds vary from that of the ground. Wind gusts can create dangerous situations. When using an aerial platform or a telescopic fork at great heights, it is essential, from a safety perspective, to measure the wind speed.



Safety harness

720304



Safety vest

Size L/XL

575737



Safety line

720303



Fastening strap for the TMT truck-mounted forklift

7272410PT



Triangle + MANITOU safety vest

Make sure you equip all your vehicles.

575849

Peripherals Components

Comfort, Cabin & Safety



Fuel tank caps

37mm	Hydraulic tank cap	Metal - breather vent	62415	60mm	Fuel tank cap	Plastic - Chain No key	256923
37mm	Fuel tank cap	Plastic - Vent - No key	225200	60mm	Fuel tank cap	Vent With Key (supplied)	257027
60mm	Brake fluid tank cap	Plastic - level sensor	895216	60mm	Fuel tank cap	Plastic With Key (supplied)	658406
37mm	Radiator cap (engine)	Metal	745061	37mm	Fuel tank cap	Operates with key ref. 184818 (Manitou key)	266203
37mm	Radiator cap (engine)	Metal	947388	60mm	Engine oil cap	Plastic	550493
45mm	Expansion tank cap	Plastic	228805	45mm	Engine oil cap	Plastic	564172
37mm	Expansion tank cap	Metal	702369				



Electric cable reel

2 x 25 mm ² cables (brown and blue) 8.5m + 1.5m IP42	Length 10 m	206132
3 x 1.5 mm ² cables (Brown, Blue and Yellow/Green) IP55	Length 12 m	222965
2 x 1 mm ² cables IP42	Length 14 m + 1,5 m	221605



Hood fastener

With Key (supplied)	18518
With Key (supplied)	223902
With Key (supplied)	208234
Optional Key (not supplied: ref. 184818 - ignition key)	303428

Advice

For maximum reliability: your fuel filler cap should be changed every 1000 hours.



Hook

Hook for hood fastener (ref: 223902 and 208234).

79568



Hydraulic jack

Specially designed to lift your industrial forklift truck rapidly. Very convenient to use and robust, this jack is also easily transportable.

- Lifting capacity 4000 kg
- Minimum height: 60/68 mm
- Lifting height: 420 mm
- Width: 200 mm
- Weight: 32 kg.
- 6 month guarantee.

545859



Discharge indicator and hour metre

Combined in one device:

- Battery discharge indicator.
- Hour meter with LCD display.
- Universal instrument, reliable and accurate, even in extreme operating conditions.

516318



Hour metre

Hour metre with three connectors, available in AC/DC and DC.

Can be used for:

- Maintenance scheduling.
- Confirmation of leasing periods for material handling and transportation machines.

621064



Analog Clock

For dashboards of MANITOU MT, MLT type machines.

265794



Water temperature indicator unit

- Water temperature indicator display.
- Luminous overheat indicator (included).

252212

Advice

Your dealership has a complete range of hour metres, discharge indicators, maintenance monitors and fuel gauges.















Wiper blades

Comfort, Cabin & Safety

Advice

Are your windscreen wipers worn? A wiper blade is subjected to a lot of abuse (heat, frost, bad weather, etc.) which is responsible for its deterioration. Look at your windshield. Smudges, streaks, scratches, non-wiped areas or noise are often the tell-tale signs of worn out blades. It is time to change your wipers!

Wiper blades

	Rear windscreen	746486		Length 700 mm	193155
	Length 280 mm	746458		Length 800 mm	198290
	Length 330 mm	182819		Length 410 mm Thin clip	705950
	Length 380 mm	551841		Length 410mm - attached by screw	54557
	Length 500 mm	85282		Length 610 mm	746757
	Length 600 mm	167787		Length 910 mm Attached by a through screw	602925
	Length 670 mm	746456		Length 620 mm Attached by a through screw	551874



Roof windscreen wipers (Kit)

211526

Advice

In addition to the windscreen cleaning effect, the MANITOU windscreen washer increases the effectiveness of the wipers. Check out the Maintenance chapter for more details on this product.

Rear-view mirror

Comfort, Cabin & Safety

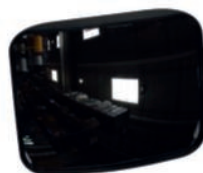

Rear rear-view mirror attachment

- Dim. 200 x 155 mm.
- Comes with shank and screw mount.

305613



Forward right rear-view mirror

- Dim. 400 x 180 mm.
- With mounting bracket and screw.
- High impact resistance.

256484



Right rear-view mirror

- Dim. 240 x 160 mm.
- Holder adjustment via screw system.
- Cabin mounting with angled mounting bracket.

572281OPT



Right front wing rear-view mirror

- Dim. 420 x 220 mm.
- Wide angle.
- Central mounting fits all machines.

74367



Left rear-view mirror

- Dim. 220 x 160 mm.
- High impact resistance, large Ushaped mounting elbow (gray colour).
- Reinforced mount.
- Fits trucks M, MSI, TMT, MT and MLT.

205809

Advice

A shared vision of safety: We offer a range of high performance rear-view mirrors to ensure your safety during your maneuvers regardless of your working environment or machine. Dimensions, impact resistance, optical quality, simple mounting system... Because your requirements are important to us, we will respond to them, point by point. If the trailer that you are towing is wider than the tractor vehicle or the visibility is obscured in the rear-view mirror, a second outside rear-view mirror on the right side of the cabin is recommended.



Left rear-view mirror

- Dim. 220 x 160 mm.
- With mounting bracket and screw. High impact resistance.
- Mounting reinforced with a joint.

299485



Left rear-view mirror

- Dim. 240 x 150 mm.
- Wide viewing angle.
- Mounted on angled mounting bracket with offaxis bracket.

551451

Advice

Safety: Poor visibility makes maneuvers harder and can cause problems. MANITOU offers you a selection of high quality rear-view mirrors to enhance safety and facilitate your work.



Outside right rear-view mirror

- Dim. 225 x 145 mm.
- Privilege range.

Complete package (mirror + mount)	746447
-----------------------------------	---------------

Mirror only	745527
-------------	---------------



Cabin internal rear-view mirror

- Dim. 175 x 120 mm.
- Mount included.Privilege range.

745352



Panoramic mirror

- Reduces blind spots for maximum safety.
- Offers a 180° visual field for perfect vision.
- Easy and practical mounting system with threaded screw.

545816

Advice

Servicing products like windshield washer or de-icer available. See chapter Servicing & maintenance.







**MACHINE
ATTACHMENT &
WAREHOUSING
EQUIPMENT**

Rehandling and loading equipment	102
Handling suspended loads	111
Personnel lifting equipment	114
Additional equipment	116
Warehousing equipment	118

Rehandling and loading equipment

Machine Attachment & Warehousing Equipment

Advice

According to standard ISO 5057, the forks that are worn down by 10% must be replaced without fail. Upon request, a certificate of compliance may be presented upon delivery of the forks. Other models of forks are available. Please consult your dealer for information.



Pin-type forks for forklifts

For floating fork carriages.

- Truck capacity: from 2600 to 10000 kg
- Section (width x thickness) : 100 x 50 to 200 x 80
- Length : from 1200 to 2000 mm.

Non-exhaustive list. The compatibility of the attachments depends on your machine model. Contact your dealer.

Length	Height	Width	
1200 mm	45 mm	125 / diam. pin: 50	415801
1200 mm	40 mm	125 / diam. pin: 60	211922
1500 mm	70 mm	200 / diam. pin: 80	719178



Industrial forklift forks

Manitou forks are available for ISO 2328 (FEM) standard, equivalent to standard NF H96-406, also known as FEM I - FEM II - FEM III and FEM IV – A or B. You are assured that good quality materials are used and the equipment complies with international safety standards.

- Truck capacity: from 700 to 10000 kg
- Section (width x thickness): 80 x 30 to 150 x 60 mm
- Length: from 800 to 1200 mm

Non-exhaustive list. For the SPECIAL forks: see your dealer for details.

	Length	Height	Width	
Standard 2A	1100 mm	40 mm	100 mm	415689
Standard 2A	1200 mm	35 mm	100 mm	486592
Standard 2A	1200 mm	40 mm	100 mm	415691
Standard 3A	1200 mm	45 mm	125 mm	415618
Standard 3A SPECIAL	1200 mm	40 mm	122 mm	415728
Standard 2A	1200 mm	40 mm	125 mm	415164
Standard 2A SPECIAL	1200 mm	45 mm	125 mm	415835
Standard 3A	1200 mm	50 mm	125 mm	415652
Standard 3A	1200 mm	50 mm	150 mm	578097



Fork handling device

The ideal solution for easily raising and lowering the forks.

Saves time and reduces manual handling : no back pain !

744889

Advice

The compatibility of the attachments depends on the model of machine. Follow the manufacturer Manitou's guidelines. Contact your dealer for advice. For forks servicing, think to use crack detection kit. See chapter Servicing & maintenance.



Fork wear callipers

The Fork wear callipers are used to control whether the forks are worn. Check the degree of wear on your forks easily for your safety and that of others.

WARNING: maximum wear and tear tolerance of the forks: 10% with regards the original level.

489628



Fork locking pins

FEM II	588323
FEM III	419742
FEM IV	453807



Tilting fork carriage (TFC) for single carriage

Solution for simple handling.

- Standard load file, bolted as an optional extra.
- FEM fork as standard, length of forks according to model.
- Movable forks.
- Compatibility of the attachments depends on the model of machine. Contact your dealer.

		Width	Capacity
PFB 25 N	FEM II	1020 / 1260 mm	2500 kg
PFB 35 N	FEM III	1260 / 1470 / 1580 mm	3500 kg
PFB 45 N	FEM III	2000 / 1260 / 1670 mm	4500 kg
PFB 75 N	FEM IV	1200 / 1750 / 2000 mm	7500 kg
PFB 90 N	FEM IV	1200 / 1750 / 2000 mm	9000 kg

Advice

How to use the fork controller:

The original level B corresponds to 90% of the original thickness of the fork arm. The threshold for wear and tear must not be exceeded in order to comply with safety standards.

Level A = original level Alert

Level B = alert level that corresponds to 10% wear and tear.

Step 1: control on the fork's vertical area: The aim is to determine the original level on a segment which has not been subjected to wear and tear. Position the upper teeth on the section.

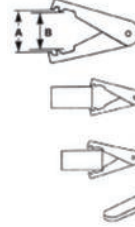

Step 2: Control the fork's heel:

Extend the controller on to the horizontal section and review:

- If the thickness is equal to or less than level A, the fork is partially good.

- If the thickness is equal to or less than level B, the fork must be replaced.



Floating fork carriages

Solution adapted to non-stabilised ground.

Load file as standard, bolted as optional extra.

- FEM pin-type forks as standard, length of forks according to the model. Movable forks.
- Truck capacity: from 2600 to 10000 kg Section (width x depth): 125 x 40 to 200 x 80.
- Length: from 1100 to 2000 mm.

The compatibility of the attachments depends on the model of machine. Contact your dealer.

		Width	Capacity
TFF 29 N		1040 / 1300 mm	2900 kg
TFF 35 N		1040 / 1300 mm	3500 kg
TFF 4 T	MRT only	1030 mm	4000 kg
TFF 45 N		1040 / 1300 mm	4500 kg
TFF 5 T	MRT only	1030 / 1300 / 1800 / 2000 mm	5000 kg
TFF 5,5 T	MRT only	1030 / 1300 mm	5000 kg
TFF 75 N		1430 mm	7500 kg
TFF 90 N	MHT only	1425 mm	9000 kg



Construction bucket

An effective solution for earthmoving work.

- Specially designed for handling materials with a maximum density of 2100 kg/m³.
- Bucket fitted with interchangeable teeth especially for earthmoving.
- Level plate for better work accuracy.
- Dig, level, move the earth... everything is possible.

* References dedicated to machines equipped with integrated side shift carriage (ISSC / TDSL).

		Width	Capacity	Attachment weight	
CBC 650 L 1850	6 teeth	1850 mm	650 L	320 kg	654473
CBC 700 L 1950	6 teeth	1950 mm	700 L	330 kg	654472
CBC 800 L 2250	6 teeth	2250 mm	800 L	385 kg	654471
CBC 800 L 2250 fitted with side shift carriage	6 teeth	2250 mm	800 L	385 kg	52000363 *
CBC 900 L 2450	8 teeth	2450 mm	900 L	410 kg	654470
CBC 900 L 2450 fitted with side shift carriage	8 teeth	2450 mm	900 L	410 kg	52000364 *



Corner sections

48949



Teeth

Applicable to all Manitou buckets with teeth.

bracket	52512880
pin	52512881
tooth	52512882



Construction bucket 4 in 1

The 4-in-1 function allows the choice of use of the bucket ranging from normal bucket, grader blade, bulldozer blade to even clamshell bucket... Handling material with a maximum density of 2100 kg/m³.

Multi-use:

- Loading bulk cargo.
- Precise filling of a ditch.
- Clearing / quick levelling of the site or gripper for certain materials.
- Interchangeable teeth for a better longevity.
- Rear counter blade for ground levelling.
- Sides fitted with teeth for cylindrical object handling.

Advice

Need to connect your hydraulic attachments quickly?
Install a Mach II connection, see page 63.

		Width	Capacity	Attachment weight	
CB4x1 700 L 1950	5 teeth	1950 mm	700 L	640 kg	751402
CB4x1 850 L 2300	6 teeth	2300 mm	850 L	735 kg	751401
CB4x1 900 L 2450	7 teeth	2450 mm	900 L	765 kg	751465

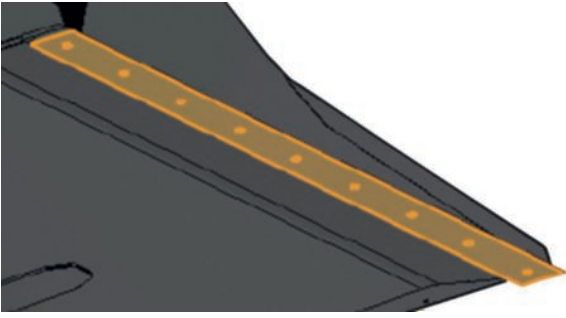

Blades for buckets

Non-exhaustive list of blades and blade holders for baskets.

Other references available : contact your MANITOU dealer for complementary information.

		Length	
Reversible, removable blade HB400 18 holes	BASKET CBG	2450 mm	219785
Reversible, removable blade HB400 17 holes	BASKET CBG	2300 mm	204622
Blade 150 x 16 HB400	BASKET CBA	2450 mm	190066
Blade 150 x 16 HB400	BASKET CBA	2500 mm	190869
Reversible, removable blade HB400 17 holes	BASKET CBG	2100 mm	229232
Blade 150 x 16 HB400	BASKET	2250 mm	190388
Blade 150 x 16 HB400	BASKET CBA	2050 mm	221672
Blade 150 x 20 HB400	BASKET CBR /CBC	1850 mm	235211
Reversible, removable blade HB400 18 holes	BASKET CBG	2480 mm	317295



Agricultural multifunction grab bucket - MS-

Specially adapted for the following applications: handling manure, loading bales for mulch, handling compost or organic waste with a density less than or equal to 1200 kg/m³.

- MS hook with welded mechanical and reinforced teeth for intensive work.
- Powerful hook with complete opening to enable work against walls. (except 790677).
- Resistant bucket and powerful jaw for optimum performance.
- Closed and removable panel kit for better adjustment.
- Bolted wear blade 400 HB for better longevity.

*Specific reference for Manitou machine type MLT 845.

		Width	Capacity	Attachment weight	
CBG 1850 DA MS	6 hooks	1850 mm	960 l	630 kg	790302
CBG 2100 MS	7 hooks	2100 mm	1090 L	681 kg	790304
CBG 2300 MS	7 hooks	2300 mm	1190 L	720 kg	790306
CBG 2450 MS	7 hooks	2450 mm	1270 L	742 kg	790308
CBG 2450 MS MLT845	7 hooks	2450 mm	1270 L	742 kg	790677 *



Agricultural multifunction grab bucket - FO

Specially adapted for the following applications: handling manure, loading bales for mulch, handling compost or organic waste with a density less than or equal to 1200 kg/m³.

- FO hook with forged teeth for occasional work with bales.
- Powerful hook with complete opening to enable work against walls.
- Resistant bucket and powerful jaw for optimum performance.
- Closed and removable panel kit for better adjustment.
- Bolted wear blade 400 HB for better longevity.

Refer to the manitou preconsisations for the attachment compatibility with your machine type.

		Width	Capacity	Attachment weight	
CBG 1850 DA FO	7 hooks	1850 mm	1030 L	636 kg	790303
CBG 2100 FO	8 hooks	2100 mm	1170 L	686 kg	790305
CBG 2300 FO	9 hooks	2300 mm	1280 L	728 kg	790307
CBG 2450 FO	9 hooks	2450 mm	1370 L	750 kg	790309



Agricultural bucket

Specially adapted for handling bulk material with a maximum density of 1000kg/m³. (For CBA 3000 L: maximum 800 kg/m³).

- Convex shape for easy loading and unloading operations.
- Quick filling and tipping.
- Ideal for working with a silo, loading a trailer, cleaning out the hen house or for handling cereals.
- 3° angle between the bucket's bottom line and the cutting edge for more longevity.
- 400 HB welded cutting edge.

*Optional 500 HB bolt-on wear plate for better longevity. Consult your dealer.

	Width	Capacity	Attachment weight	
CBA 1500 L 2050 DA	2050 mm	1507 L	509 kg	653035
CBA 1700 L 2100 S3	2100 mm	1643 L	522 kg	570549
CBA 2000 L 2250 S3	2250 mm	1955 l	650 kg	790540
CBA 2000 L 2250 BLADE WEAR AND TEAR BOLTED 500HB	2250 mm	1955 L	650 kg	790541 *
CBA 1500 L 2450	2450 mm	1524 L	500 kg	570547
CBA 1500 L 2450 BLADE WEAR AND TEAR BOLTED 500HB	2450 mm	1524 L	500 kg	570548 *
CBA 2000 L 2450 S3	2450 mm	1998 L	607 kg	570551
CBA 2000 L 2450 BLADE WEAR AND TEAR BOLTED 500HB	2450 mm	1998 L	607 kg	570552 *
CBA 2500 L 2450 S3	2450 mm	2508 L	701 kg	570553
CBA 2500 L 2450 BLADE WEAR AND TEAR BOLTED 500HB	2450 mm	2508 L	701 kg	570554 *
CBA 3000 L 2500 S3	2500 mm	3003 L	774 kg	570555
CBA 3000 L 2500 BLADE WEAR AND TEAR BOLTED 500HB	2500 mm	3003 L	774 kg	500701 *
CBA 2500 / 4000 LDR large capacity	2500 mm	4000 L	1035 kg	52000060



Rehandling bucket

Designed for handling materials with a density < than 2100 kg/m³ (earth, sand, gravel, cereals).

- Reinforced structure (base, blade and sides).
- Level plate for greater precision.
- An ideal tool to clear building sites.

Optional bolt-on wear plate for better longevity. Dedicated versions for machines equipped with an intergated side shift (TDSL).

Ask your MANITOU dealer for further information.

	Width	Capacity	Attachment weight	
CBR 730 / 1850 for MLT 625 / MT 625/ 1235	1850 mm	735 L	330 kg	571831
CBR 780 / 1950 for MLT634/ 735/ 741 MT 732 /1440/ 1740	1950 mm	778 L	340 kg	570613
CBR 850 / 2100 for MLT 627	2100 mm	843 L	358 kg	653047
CBR 900 / 2250 for MLT 627/ 629/ 634/ 735/ 741/ MT 732/ 1030/ 1235/ 1440/ 1740/ 1840	2250 mm	904 L	367 kg	653749
CBR 1000 / 2450 for MLT 634/ 732/ 735/ 741/ 840/ 845/ 1040/ MT 732/ 732.3B/ 835/ 932.3B/ 1030/ 1135/ 1235/ 1335/ 1435.3B/ 1440/ 1740/ 1840	2450 mm	990 L	388 kg	654716



Environment grab bucket

Large capacity: increased capacity for a massive work output in waste handling applications (density < 1).

Increased water capacity (1500 L) to handle bulk materials.

- Welded blade on grab available for paper handling applications (contact your Manitou dealer).
- Grab-integrated spill guard.
- Reinforced teeth.
- Mechanical rotation stops.

For any other particular use, please contact your dealer.

		Width	Capacity	Attachment weight	
CBG 2480 / 2200 EN	5 hooks	2480 mm	2200 L	1350 kg	790657



Feeding bucket

For all types of silage.

- Clean cut on the front limiting the re-closure of the silage.
- Powerful attachment for a quick cut with a lateral blade for a convenient cut. Hook teeth (except ref. 757723) for a perfect cut and easy maintenance.
- Engine running on low RPM : lower fuel consumption.

Refer to the Manitou preconisations for the attachment compatibility with your machine type.

	Width	Capacity	Attachment weight	
SHG 1700 / 850 MLT 629 / 634 / 735	1865 mm	850 L	710 kg	757723
SHG 1600 / 1200 MLT 625	1654 mm	1200 L	705 kg	52000380
SHG 1800 / 1350 MLT 629	1850 mm	1350 L	749 kg	52000381
SHG 2200 / 1650 MLT 634 / 735 / 741	2254 mm	1650 L	835 kg	52000382
SHG 2400 / 1800 MLT 840 / 1040	2454 mm	1800 L	936 kg	52000383



High capacity Manure grab

Adapted to straw-manure (density <math><700 \text{ kg/m}^3</math>).

Increased capacity for higher work output.

- Reinforced structure for intensive applications.
- Complete jaw opening over 90° allows working flush with wall.
- Grab rotation stops for an improved cylinder longevity
- Teeth: diameter 45 mm, 939 mm:
- Tines: diameter 45 mm, 1100 mm.

For any other particular use, please contact your Manitou dealer.

		Width	Capacity	Attachment weight	
FMG 2100 / 1800	MLT 6294/10 teeth	2100 mm	1800 L	470 kg	52000082
FMG 2450 / 2000	MLT 634/735/741/840/10405/12 teeth	2435 mm	2001 L	686 kg	790534



Manure fork with grapple

Large capacity for handling material with a density <math><1200 \text{ kg/m}^3</math>. Bolt-on teeth and tines for easy maintenance.

- Strong and reinforced structure for intensive activities.
- Complete jaw opening over 90) allows working flush with wall.
- Grab opening adjustment.

Other references with lower capacity are available. Please consult your dealer.

		Width	Capacity	Attachment weight	
FFGR 2100 - 7 / 10 teeth		2100 mm	1300 L	492 kg	751403
FFGR 2400 - 8 / 12 teeth		2400 mm	1520 L	528 kg	751405

Advice

For all machine attachments, refer to the Manitou preconsisations for the compatibility with your machine type.



Super compact bale clamp

- Bale clamp: max. diameter 1.6 m / maximum height 0.8 m.
- Rounded forged teeth for clean and easy handling.
- 2 X 2 teeth.
- Non-synchronised closure.

PBG 2X2 : for MLT 625/ 629/ 634/ 735/ 741/ 840/ 845/ 1040

Capacity	Attachment weight	
800 kg	158 kg	757639



Classic bale clamp

- Bale clamp: max. diameter 1.8 m / maximum height 1.2 m.
- Rounded forged teeth for clean and easy handling.
- 2 X 4 teeth.
- Synchronised closure.

PBG 2X4 : for MLT 625/ 629/ 634/ 732/ 735/ 741/ 840/ 845/ 960/ 1040

Capacity	Attachment weight	
1000 kg	262 kg	757612



Square bale clamp

- Bale clamp: max. diameter: 1.8 m / max. height: 1.2 m
- High work output for all square-bale and round-bale applications.
- Side clamping ensures perfect grip even when the clamp is partially loaded and easy under-roof operation.
- Foldable lower tines and complete opening for more travel safety.
- 2 x 7 / 3 teeth

CLBS 2x7 / 2100: for MLT 840 / 1040

Length	Height	Capacity	Attachment weight	
1800 mm	3010 mm	2100 kg	780 kg	52000015



Intensive bale clamp

- Bale clamp: max. diameter 1.8 m / maximum height 1.2 m.
- Rounded forged teeth for clean and easy handling.
- Synchronised closure.
- 2 X 4 teeth.
- Optional: 2 lower tines (680 mm, diameter 35 mm) for square bale handling.

P2BG 2X4 : for MLT 629/ 634/ 732/ 735/ 741/ 845/ 960/ 1040

	Capacity	Attachment weight	
	1500 kg	262 kg	790518
option lower tines MLT 629/ 634/ 732/ 735/ 741/ 845/ 960/ 1040			790521



Wrapped bale clamp

- Wrapped bale clamp: min. diameter 1 m / max. 1.7 m.
- Smooth tubular and articulated structure that avoids film damage.
- Non-synchronised closure.
- Anti-wear bushes, self-lubricated for longer longevity.

PBE: for MLT 625/ 629/ 634/ 732/ 735/ 741/ 840/ 845/ 960/ 1040

Capacity	Attachment weight	
1000 kg	242 kg	757613



Mixed bale clamp

Easy to use: function can be changed in less than 3 minutes and without tools (round bale clamp: max. diameter 1.6 m; wrapped bale clamp: min. diameter 1 m / max. 1.8 m; square bale clamp: max. height 1.2 m)

- Rounded forged teeth and forged lower tines for easy and clean handling.
- Adjustable angle of tilt (2 carriage positions possible).
- 2 x 3 teeth.
- Synchronised or non-synchronised closure.

MBC 2X3: for MLT 625/ 629/ 634/ 735/ 741/ 840/ 960

Capacity	Attachment weight	
800 kg	200 kg	790506



Square bale forks

Simple and economical solution for bale handling.

- Simultaneous handling of 4 bales (H= 800 mm).
- Attachment adapted for road traffic.
- Foldable tines and frame : suitable for road use and under-roof handling.
- Folding teeth on top of the chassis.

FB 1900 / 1700

Length	Capacity	Attachment weight	
1900 mm	1700 kg	215 kg	790699

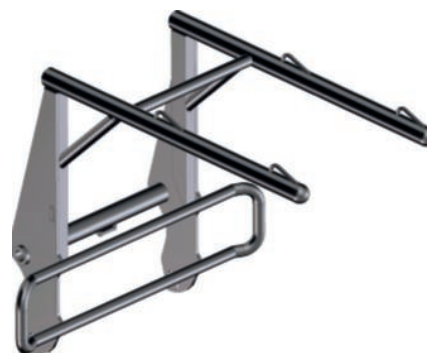

Big-bag handler

Increase the efficiency & safety of all big-bag handling solutions.

- main structure made of tubes : limits the risk of bag damage or slippage.
- Handles big-bags with 1,2 ou 4 loops.
- Anti-swing bag stabilizer : increases stability.

Offset	Capacity	Attachment weight	
1570 mm	2400 kg	186 kg	931627

Advice

The compatibility of the attachments depends on the model of machine. Follow the manufacturer's guidelines of Manitou. Contact your dealer for more information.

Handling suspended loads

Machine Attachment & Warehousing Equipment

Advice

Important: as your truck includes an attachment for suspended loads (winch, crane jib, crane jib with winch, hook...), it must be fitted with an automatic shut-off for movements. Since 1st October 2010, all telescopic trucks sold in Europe are fitted as standard with an aggravating movement shut-off.



Crane

2 forward reach positions for more flexibility in performing daily tasks.

- Safety: homologated self locking swivel hook.
- Length: 1 708 mm permissible weight 1200 kg (for crane jib 4000 kg).
- Length 2: 2708 mm permissible weight 210 kg (for crane jib 4000 kg).

		Capacity	
P 4000	MT 732/ 835/ 932.3B/1030/ 1135/ 1235/ 1335/ 1435.3B/ 1440/ 1740/ 1840.	4000 kg	653226
P 6000	model E-RECO MRT Easy.3B/ Privilège +/ 3255 - Length1 808 mm permissible weight 2000 kg Length 2 2708 mm permissible weight 282 kg	6000 kg	921322



Hydraulic winch - 3T to 22T

- Oil immersed negative brake for low running costs.
- Sheaving of the cable for increased traction (except winch 3T).
- Standard cable guide for easy operations.
- Limit switch above and below.
- Safety: homologated self locking swivel hook.

The compatibility of the attachments depends on the model of your machine. Please contact your dealer.

Advice

Important: Hydraulic return line kit is mandatory for using this attachment. Please contact your MANITOU dealer for more information.

		Capacity	Attachment weight	Cable length	
WINCH 3T MT 835/ 1135/ 1335	speed 24 M/mm	3000 kg	395 kg	49 m	921337
WINCH 5T MRT Privilège +	speed 21.5 M/mm	5000 kg	510 kg	51 m	921341
WINCH 7,2T MRT 3255	speed 19.4 M/mm	7200 kg	700 kg	76 m	934500
WINCH 8T MHT 780	speed 20 M/mm	8000 kg	850 kg	60 m	882842
WINCH 9T MHT 790	speed 22.5 M/mm	9000 kg	850 kg	30 m	939030
WINCH 12T MHT 1490	speed 21.5 M/mm	12000 kg	1185 kg	60 m	710405
WINCH 18T MHT 10120	speed 12 M/mm	18000 kg	1550 kg	60 m	909010
WINCH 22T MHT 10225	speed 12 M/mm	22000 kg	1550 kg	60 m	909011



E-Reco (Recognition control)

E-RECO, an attachment recognition system for greater simplicity.

Manitou is offering, as standard, its recognition system for attachment on its new-generation of rotary telescopic trucks MRT EASY and MRT PRIVILEGE+. The system uses radio identification technology (RFID), which is very widely used in industry and retail. This autonomous technique can remotely recover and record data. The machine detects the attachment on the head of the boom, analyses its data and directly proposes the corresponding working configuration. This technology provides the load chart in real time, taking into account the position of the machine's stabilisers and in accordance with the mobile crane standard.



Extension jib

Perfect for transporting and placing beams, frames...
Comfort and safety in approach and placement activities for material.
The range and capacity of the crane jib varies according to the function of the models.

- Design improves the forward reach of the telehandler.
- Tubular structure offering optimum weight/rigidity ratio.
- Safety: homologated self locking swivel hook.

		Capacity	Attachment weight	Offset	
P600	MT 732/ 835/ 932/ 1030/ 1135/ 1235/ 1335/ 1435.3B/ 1440/ 1740/ 1840	650 kg	210 kg	3950 mm	653228
P600	model E-RECO MRT Easy.3B / Privilege + / 3255	650 kg	210 kg	3950 mm	921316
P1000	model E-RECO MRT Easy.3B / Privilege +	700 kg	210 kg	3950 mm	921317
P1500	model E-RECO MRT Easy.3B / Privilege + / 3255	800 kg	186 kg	2820 mm	921319
P2000	model E-RECO MRT Easy.3B / Privilege + / 3255	900 kg	190 kg	2530 mm	921320

Advice

Always respect Manitou preconditions and load chart to link each attachment to your machine.



Frame mounting hook

Fitted with a crane jib, your MANITOU is fitted with great lifting capacity to handle heavy and voluminous loads.

- Very compact attachment that maintains the machine's stability.
- Safety: homologated self locking swivel hook.
- Basic attachment for safe suspended load handling.

Other references of frame mounting hook available. Please consult your dealer following your type of machine.

		Capacity	Attachment weight	
PC 50	model E-RECOMRT MRT Easy.3B / Privilege + / 3255	5000 kg	120 kg	921335



Extension jib with winch

Perfect for transporting and placing beams and frames.

- Design improves the forward reach of the telehandler.
- Turns your telehandler into a crane.
- Safety: homologated self locking swivel hook.

		Capacity	Attachment weight	Offset	
PT 600 MT 932/ 1030/ 1440/ 1840	cable 40 speed 94 M/mm	600 kg	278 kg	4104 mm	921325
PT 600 MRT Easy.3B / Privilege +/- 3050	model E-RECO cable 40 speed 94 M/mm	600 kg	278 kg	4104 mm	921325
PT 1000 MRT Easy.3B / Privilege +/- 3050	model E-RECO cable 56 speed 44 M/mm	1000 kg	299 kg	4104 mm	921326
PT 1500 MRT Easy.3B / Privilege +/- 3050	model E-RECO cable 37 speed 48 M/mm	1500 kg	324 kg	3008 mm	921330
PT 2000 MRT Easy.3B / Privilege +/- 3050	model E-RECO cable 49 speed 24 M/mm	2000 kg	354 kg	2517 mm	921331



Slewing crane

Slewing crane +/- 15° for better flexibility in narrow buildings or industrial sites.

- Better work output in performing daily tasks.
- Safety: homologated self locking swivel hook.
- The range and capacity of the jib varies according to the model.

Check the compatibility of your Manitou machine with the attachments, by consulting your dealer.

	Capacity	Attachment weight	Offset	
PO 600 / 2500	600 kg	320 kg	2500 mm	784641
PO 1000 / 1500	1000 kg	275 kg	1500 mm	784642
PO 2000 / 1000	2000 kg	255 kg	1000 mm	784643

Personnel lifting equipment

Machine Attachment & Warehousing Equipment

Advice

The compliance of the baskets with the minimum requirements of strength and safety is evaluated according to standard NF EN 280 PEMP class, either according to the elevation mode (group), or to the possibility of translation (type). To use this equipment safely, it is necessary to follow the conditions given in the instruction manual, from the rules of prevention: wind speed, resistance and evenness of the ground, risk of being struck by a vehicle, to collide with a fixed structure with basket, driver being thrown out of the cab. These lifting devices must only be operated by trained and authorised personnel whilst following the guidelines for use. Imperatively respect load chart.



Fast opening platform

- Maximum safety and efficiency in lifting people.
- Complete opening / closing in 50 seconds.
- Legally approved for 3 people maximum.
- Accessible from 3 sides (version D: side panel + 2 smooth).
- Overload sensor, non-slip metal floor.
- Rotation +/- 90°.

Consult your dealer for further information about attachment compatibility with your machine.

		Width	Capacity	Attachment weight	
PSE 4400 / 365	model E-RECO MRT Easy.3B / Privilege + / 3255	2250 to 4400 mm	365 kg	650 kg	914500
PSE 4400 / 365 D	MT 1135HA/ 1335HA/ 1440HA/ 1840HA	2250 to 4400 mm	365 kg	670 kg	939021
PSE 4400 / 365 D	model E-RECO MRT Easy.3B / Privilege + / 3255	2250 to 4400 mm	365 kg	670 kg	939750
PSE 4400 / 1000 D	MT 1135HA/ 1335HA/ 1440HA/ 1840HA	2250 to 4400 mm	1000 kg	1030 kg	939022
PSE 4400 / 1000 D	model E-RECO MRT Easy.3B / Privilege + / 3255	2250 to 4400 mm	1000 kg	1030 kg	939500
PSE 4400 / 700 D	MT 1135HA/ 1335HA/ 1440HA/ 1840HA	2250 to 4400 mm	700 kg	1030 kg	939023
PSE 4400 / 700 D	model E-RECO MRT MRT Easy.3B / Privilege + / 3255	2250 to 4400 mm	700 kg	1030 kg	939020

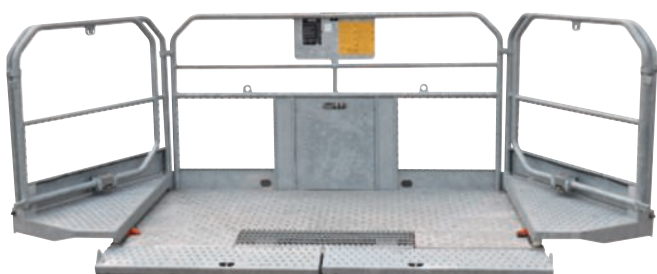

Roofer platform

- Maximum safety and efficiency in lifting people.
- Cutting edge platform design for roof work.
- Legally approved for 3 people.
- Safety: front opening only if in contact with the roof.
- overload, roof presence and physical locking sensor.

Contact your deal for further information and the attachment compatibility on your machine.

		Width	Capacity	Attachment weight	
NC 365	MT 1135HA/ 1335HA/ 1440HA/ 1840HA	2400 to 3700 mm	365 kg	920 kg	788789
NC 365	model E-RECO MRT Easy.3B / Privilege +	2400 to 3700 mm	365 kg	920 kg	923309
NC 1000	MT 1135HA/ 1335HA/ 1440HA/ 1840HA	2400 to 3700 mm	1000 kg	920 kg	788791
NC 1000	model E-RECO MRT MRT Easy.3B / Privilege + / 3255	2400 to 3700 mm	1000 kg	920 kg	921294



3D basket

- Maximum safety while lifting people.
- Positive and negative work area, 340° boom rotation.
- Telescopic arm + negative working area allowing under-bridge operations.
- Legally approved for 2 people.
- Pendular platform allows work under-bridges.
- Safety: boom position sensor, locking pin presence sensor.
- Anti-slip metal floor.

Contact your dealer for further information about attachment compatibility on your machine.

		Width	Capacity	Attachment weight	
Basket 3D SYSTEM	model E-RECO MRT 1440/ Easy.3B 1840/ MRT 1850 Privilege	1100 mm	200 kg	1100 kg	921311
Basket 3D SYSTEM	model E-RECO MRT 2150 / 2540 + privilege/ MRT 3255	1100 mm	200 kg	1100 kg	921312
Assembly kit	ASSEMBLY KIT MRT Easy.3B 1440/ Easy.3B 1840 / MRT 1850/2150 + Privilege	-	-	-	739476
Assembly kit	ASSEMBLY KIT MRT 2540 + Privilege	-	-	-	741121
Assembly kit	ASSEMBLY KIT MRT 3255	-	-	-	774384

Advice

Check the compatibility of your equipment with your machine. Always follow the manufacturer's guidelines of Manitou. Refer to the operating manual.



Platform with winch

Hydraulic winch mounted on the hydraulically lifted jib more versatility (slewing : manual).

- legally approved for 3 people.
- 2 possibility of 2 platform capacity combinations.
- Rotation 90 °.

Contact your dealer for further information about attachment compatibility on your machine.

		Width	Capacity	Attachment weight	
BASKET ARG 450kg / 450kg	model E-RECO MRT Privilege+/ 3255 Cable length: 30 m	2250 to 4000 mm	450kg + 450kg	1330 kg	914440
BASKET ARG 600kg / 300kg	model E-RECO MRT Privilege+/ 3255 Cable length: 30 m	2250 to 4000 mm	600kg + 300kg	1330 kg	923336

Additional equipment

Machine Attachment & Warehousing Equipment



Crane skip

Ideal for transporting building materials that can be dumped, such as concrete, sand and gravel...

- Optimized shape for efficient distribution.
- Manual opening or hydraulic opening as an option.
- Fitted as standard with lifting hoop
- Multi-socket sleeve with possible 3 positions.
- in options : hydraulic opening and flexible tube.

Other references with large capacities are available. Ask your dealer.

	Width	Capacity	Attachment weight	
GL 400 MT 625/ 732/ 1030/ 1235/ 1440/ 1740/ 1840/ MRT Easy/ Privilege +	1250 mm	400 L	166 kg	174372
GL 600 MT 625/ 732/ 732.3B/ 932.3B/ 1030/ 1235/ 1435.3B/ 1440/ 1740/ 1840/ MRT Easy/ Privilege +	1600 mm	600 L	290 kg	174373



High pressure cleaner

- 45 minutes of autonomy at 200 bars.
- Pressure regulation system (from 10 to 200 bars).
- Manometer as standard.
- Easy to hitch on standard forks.
- Nozzle spray for powerful and accurate cleaning.
- 40 metre hose reel.

		Height	Width	Capacity	
VHPC 600	MLT 634/ 735/ 741/ 840/ 1040	1520 mm	1451 mm	600 L	790335



Pickup sweeper

Sweep and pick-up in one operation.

- Up to 2500 m² cleaned in 10 minutes.
- High quality sweeping even on rough terrain.
- Polyester ad steel brush for perfect sweeping along walls or side walks.
- Interchangeable side brush (right or left side).
- Swivel wheels for an easy driving process.

		Width	Capacity	Attachment weight	
BRB 1600	MLT 625/ MT 625	2000 mm	380 L	775 kg	790313
BRB 2200	MLT 634/ 735/ 741/ 840/ 960	2600 mm	530 L	925 kg	790315
BRB 2500	MLT 960	2900 mm	600 L	1000 kg	790316



Sweeper 2 in 1

Simple & efficient solution for all sweeping applications.

- Dust collector & front wheel standard.
- 2 in 1: sweeper-collector & side-pushing sweeper.
- Galvanized structure for more longevity.
- Standard version : mechanical swivel, standard wheel, and synthetic brush.
- Product designed for light & medium duty applications.
- Other options available, contact your dealer.

*Other references available following your machine type, refer to your Manitou dealer.

		Width	Capacity	Attachment weight	
SCC 2600	MLT 634/ MLT 732/ MLT 735/ MLT 741/ MLT 840/ MLT 1040 MT 625/ MT 732/ MT 835/ MT 932/ MT 1135/ MT 1335	2600 mm	250 L	450 kg	52000515*



Hooks

	Capacity	
5 T	5000 kg	479869
7,5 T	7500 kg	586182



Swivel hook

	Capacity	
With safety lock	1000 kg	12384
With safety lock	4000 kg	210743
With safety closing link	6000 kg	51022
Same model with coupling link	2000 kg	37070
Same model with coupling link	2500 kg	77058
Same model with coupling link	3000 kg	37072



Pins for attachments

Bar enables the carriage to be blocked when holding the forks in a vertical position. Recommended for travel by road.

77076



Toolbox

- Practical, removable and easy to carry.
- Easily fixed to the rear left wing for MT-MRT models and to the front of the chassis for the MLT forklifts.
- Can be secured by a padlock.
- The toolbox with mounting is specific to each type of machine. Please contact your MANITOU dealer.

Steel tool box: for the MT and MLT	252220
Steel tool box: for MRT Easy	777099
Manitou tool box	947514



Warehousing equipment

Machine Attachment & Warehousing Equipment

Manitou Pallet trucks and pallet truck spare parts

Manitou offers you a large range of pallet trucks with different materials, specific wheels and rollers, to be able to meet the long term needs of your trade and your handling requirements.

Manual or electric, standard or premium quality, low-load forks or large forks, light pallet trucks... MANITOU has rigorously selected the best suppliers to be able to bring you the technical solutions that are uniquely adapted to your needs.

Choosing the right pallet truck

The material of the wheels and rollers must be appropriate for your ground according to the surface, gradient or roughness of the ground. Each material has distinct properties to meet your needs:

polyurethane - supple and resistant and ideal for delicate floors. Good resistance to wear and tear and non-marking. Polyurethane ensures outstanding comfort of use that is also silent and durable. Great resistance to indentations and chafing. Good protection of the ground, non-staining and silent.

Vulkolan make was chosen; Vulkolan is a top of the range polyurethane. As it is hot poured, it has durability properties and outstanding resistance.

Nylon enables the motion thanks to low friction with the ground. Suitable for ground with low gradient. Non-marking. High resistance to chemical products and ideally suitable for food-processing environments, fishing and chemical industries. Rubber Silent and durable; it can be used on all surfaces, both smooth and rough. Great resistance to corrosion. Cannot burst. **Steel** Better resistance to temperature variations. Great resistance to shocks and vibrations. Better fit of the tyre on the freewheel body.

Maintenance and replacement parts

To maintain your pallet truck, consider the Manitou pallet truck parts. Use exclusively:

- Manitou hydraulic oil Industry Hydro VG32 (pn. 744638 in 5L and pn. 744637 in 20 L) for the pump. To be carried out every 6 months
- Manitou Multi-functional Extreme grease (pn. 947765 in 400 gr) for the rollers, wheels and joints. To be carried out monthly. Please refer to the instruction manual. The original MANITOU spare parts are guaranteed and comply with the original parts.

They enable the optimal performance of your material and increased the longevity. By choosing the original MANITOU parts you are investing in quality products.



Standard pallet truck

- Quicklift system: increases the lifting speed of the loads < 250 kg.
- Also available in: nylon wheel, simple/double rollers, polyurethane/nylon, with weighing function, and weighing function + printer.
- Please contact your dealer for more information

Length	Height	Width	Capacity	Weight	Rollers	Wheels	
1150 mm	85/200 mm	540 mm	2500 kg	65 kg	2x Polyurethane	2x Rubber	947544



Premium pallet truck

- Proportional valve: enables controlled lowering of the load.
- Guaranteed for 3 years.
- Also available in nylon/Vulkolan, simple/double nylon/Vulkolan rollers.

Length	Height	Width	Capacity	Weight	Rollers	Wheels	
1150 mm	85/115 mm	525 mm	2500 kg	67 kg	4x Vulkolan	2x Rubber	895819



1-ton light pallet truck

- Guaranteed 3 years.
- Manoeuvrable, light and silent, its innovative design will meet all your needs.
- its surface properties are maintained, even when exposed to corrosive agents.

Length	Height	Width	Capacity	Weight	Rollers	Wheels	
1150 mm	85/115 mm	520 mm	1000 kg	38 kg	2x Polyurethane	2x Polyurethane	895004

Advice

Fitted with chassis and extremely resistant forks, the MANITOU pallet trucks are designed to be used in demanding conditions and with repeated handling. MANITOU recommends a large range of pallet trucks to meet your needs. Our Premium range is specially fitted with wheels and rollers in Vulkolan, high-end polyurethane for an unprecedented service life. The Premium pallet trucks are guaranteed for 3 years. MANITOU also recommends the bearings and rollers as spare parts. Please contact your dealer.



Short forks pallet truck

- Ideal for handling in restricted areas (lorries, markets, paper mills, lifts...).
- Quicklift system: increases the lifting speed of loads < 250 kg.
- Also available in single/double rollers, length 800/900 mm, width 450/540 mm...

Length	Height	Width	Capacity	Weight	Rollers	Wheels	
800 mm	85/200 mm	540 mm	2500 kg	67 kg	4x Polyurethane	2x Rubber	947549



Long forks pallet truck

- Specially designed for loading long and over-sized pallets.
- Quicklift system: increases the speed of lifting the loads < 250 kg.
- Also available in: length 1500 mm and capacity 2000 kg.

Length	Height	Width	Capacity	Weight	Rollers	Wheels	
1800 mm	85/200 mm	540 mm	1500 kg	81 kg	4x Polyurethane	2x Rubber	947552



Large forks pallet truck

Pallet trucks with large forks are ideal for handling large-size pallets (e.g. pallets of bricks, pallet crates for apple production, etc.).

- Also available in: double rollers nylon/polyurethane and wheels: nylon/rubber, length: 800 mm...

Length	Height	Width	Capacity	Weight	Rollers	Wheels	
1150 mm	85/200 mm	685 mm	2500kg	72 kg	2 x polyurethane	2 x rubber	947554

Advice

MANITOU provides a large range of pallet trucks, from standard models to more specific products that meet the requirement of your job.



Low-profile pallet truck

The low-profile pallet trucks are indispensable in moving loads on low pallets.

Height of the forks in lowered position: 51 mm.

- Quicklift system: increases the speed of lifting loads < 250 kg.
- Also available in length 1500 mm / Capacity: 2000 kg.

Length	Height	Width	Capacity	Weight	Rollers	Wheels	
1150 mm	51/165 mm	540 mm	2000 kg	71 kg	4x Polyurethane	2x Rubber	787358



Electric high lift pallet truck

- 70 Ah/12V battery.
- 6A / 12V charger included.
- Conforms to EN 1757-4.
- Also available in manual lift, width 560 mm and 680 mm.

Length	Height	Width	Capacity	Weight	Rollers	Wheels	
1190 mm	85/800 mm	560 mm	1000 kg	159 kg	2x Polyurethane	2x Polyurethane	720270



Stainless steel pallet truck

- Designed for corrosive environments or use in places requiring strict hygiene.
- Stainless steel.
- Withstanding high pressure washing and detergents.
- Self lubricating bearings.
- Also available in: galvanised steel, rubber/nylon wheels, polyurethane/nylon rollers...

Length	Height	Width	Capacity	Weight	Rollers	Wheels	
1150 mm	85/200 mm	540 mm	2000 kg	71 kg	4x Nylon	2x Nylon	947543



Mini-hand truck

For occasional deliveries. Very light model and space-saving model. Easy to use and to handle. Fully folding and compact, fits easily into a vehicle.

- In aluminium, 6 kg.
- Dimension: unfolded: 410 x 7400 x 1100 mm -folded: 200 x 400 x 750 mm. Max. load: 90 kg.
- Full wheels: diameter: 150 mm.

720468



Dual purpose hand truck

Very practical with its double function trolley and hand truck. Easy and comfortable to grip on the frame or the handles.

- In aluminium, 17 kg.
- Dimensions: hand truck version: 520 x 470 x 1310 mm / trolley version: 520 x 1190 x 1030 mm.
- Max. load: hand truck version: 200 kg - trolley version : 300 kg.
- Inflatable tyres: diameter 260 mm.

720441



Professional hand truck

- Very resistant model with reinforced toe plate.
- In aluminium, 12.2 kg.
- Dimension: 420 x 510 x 1 330 mm.
- Max. load: 300 kg.
- Semi-inflatable tyres : diameter 250 mm.

720440



Warehouse Hand Truck

- Classic truck for day to day handling.
- Resilient model.
- Steel 8.5 kg.
- Dimension: 1232 x 536 mm.
- Max. load: 250 kg.

894215

Advice

Over 50 years of experience in concrete mixers: reliability strength and handling make the Manitou concrete mixers the tool of choice. The volume assembled in a traditional way is made of 3 reinforced elements and detachable mixers to ensure durability, ease of maintenance and optimal quality mixing. In order to tow your concrete mixer, consider the lighting and signalling device kits.



Concrete mixer BSI 280 S

- Drum volume: 340 l.
- Mixing capacity: 280 l.
- Weight with motor: 271 kg.
- Wheel diameter: 135 x 80 x 13 mm.
- Roller bearing-mounted wheels with pneumatic tyres and mounting.
- 2-position draw bar for towing in the raised or lowered position.

Electric	Electric motor MONO CV 2 Power 1.5 kW	788340
Thermal	Thermal motor reduced petrol HONDA GX 160 LX4 with transmission system by chain Net power 3.6 kW at 3600 tr/min	894268



Concrete mixer BSI 340 S

- Drum volume: 400 l.
- Mixing capacity: 340 l.
- Weight with motor: 315 kg.
- Wheel diameter: 135 x 80 x 13 mm.
- Roller bearing-mounted wheels with pneumatic tyres and mounting.
- 2-position draw bar for towing in the raised or lowered position.

Electric	Electric motor MONO CV 2 Power 1.5 kW	788342
Thermal	Thermal motor reduced petrol HONDA GX 160 LX4 with transmission system by chain Net power 3.6 kW at 3600 tr/min	894269



Concrete mixer LC 340 N

- Drum volume: 400 l.
- Mixing capacity: 340 l.
- Weight with motor: 388 kg.
- Wheel diameter: 155 x 70 x 13 mm.
- Roller bearing-mounted wheels with pneumatic tyres and mounting.
- 2-position draw bar for towing in the raised or lowered position.

Electric	Electric motor MONO CV 2 Power 1.5 kW	788338
Thermal	Thermal motor reduced petrol HONDA GX 160 LX4 with transmission system by chain Net power 3.6 kW at 3600 tr/min	894270





Scale models	126
Toys	127
Office accessories	128
Promotional items	129
Clothes	130



Scale models

Shop

Advice

Welcome to new Manitou selection.
Practical and pleasant, those objects to live and to collect are perfect for gift ideas.



Fork lift truck MSI 50 T

scale models 1/25th

482144



Rotative telehandler MRT 2150 Privilege with equipments

scale models 1/32th

929902



Telehandler MT 625

scale models 1/32nd

575868



Telescopic MLT840 with bucket

scale models 1/32nd

575895



Masted Fork lift truck MI 25D with forks

scale models 1/25th

575890



Telehandler MLT 625

scale models 1/32nd

575867



Telehandler MLT

- Toy suitable from 4 years.
- Scale models 1/87th.
- Metallic toy.
- the arm can be extended and the shovel hinges.
- Blister pack.

575910



Rotative telehandler MRT 2150

- Toy suitable from 4 years.
- Scale models 1/16th. Size: 52.7 x 16.8 x 20 cm.
- The cabin can be rotated over 360°.
- The telescopic arm can be extended and its height adjusted with the upper rotary button.
- The bucket can be replaced with other attachments, the hood can be opened.

575902



Telehandler MLT 633

- Toy suitable from 4 years.
- Scale models 1/16th. Size: 43 x 17.5 x 15 cm.
- The telescopic arm can be extended and its height adjusted with a rotary button.
- The hood can be opened and the attachment can be manipulated.

575550

Office accessories

Shop



**Ballpoint pen
BIC**

575934



**Disposable automatic
pencil BIC**

575935



Wood & steel pen

575900



Pocket book A6 format

575932



2 GO MLT840 USB Key

895306



Calculator

575848



Briefcase

17.3 x 22.5 cm

575797



A4 document holder

575816



Headphones

Great sound quality.

- Impedance: 32ohms.
- Sensitivity: 105±2dB.
- frequency response 20Hz - 20000 Hz.
- Stereo jack socket 3.5 mm.

575926



Mug club

Porcelain, compatible with coffee machine pod system.

- Height: 86 mm.
- Diameter: 82 mm.
- Capacity: 0.25 L.

575921



Power bank

- Lithium battery 2200mAh.
- Input: 5V/600-700mA.
- Output: 5V/1A.
- Charging time: 3-5h.
- 1 USB/micro USB cable.
- Diameter 2.1 x 9.2cm.

575933



Swiss knife

Also available: Wine waiter's knife (pn 575670)

575682



Working light pro

- Red ABS case covered in black rubber,
- with black ABSi hook.
- 24 white LEDs.

575922



Locking tape measure

575897



Manitou Backpack

575747



Lunch box

Red polypropylene food box. Guaranteed BPA free. Microwave and dishwasher safe.

- 2 levels with separation.
- Upper compartment is airtight.
- Comes with a white spoon and fork.

575931

Clothes

Shop



LUXE cap

- Colour: black

575709



6 panel cap

- Colour: gray/red

575744



Men T-shirt - V neck

- Color: Black
- Trendy style, high quality
- Size L (available in sizes M, L, XL and XXL)

575828



Women T-shirt - round neck

- Colour: Gray
- Slim fit, high quality.
- Size M (available in sizes S, M, L, and XL)

575946



Sleeveless jacket

575695/575696



Mens blouson jacket

- Size L (available in sizes M, L, XL and XXL)

575872



Women blouson jacket

- Size M (available in sizes S and M)

575875



Overall with zip

- Size 44/46 (available from 36/38 to 60/62)

575763

Suppliers & partners

We thank our suppliers and partners
who have contributed to this catalogue.



actispray



WÜRTH, YOUR PARTNER

Your stock management solutions signed by Würth

3 PURCHASE SOLUTIONS FOR MORE REACTIVITY



A DEDICATED AND SPECIALISED SALES REPRESENTATIVE WITH THE SUPPORT OF A MAJOR ACCOUNTS MANAGER

2,700 specialist sales representatives providing custom advice and solutions.



NEARLY 110 SHOPS THROUGHOUT FRANCE

Reserved for professionals. 4,000 off the shelf product references. A real backup solution on your doorstep.



THE ONLINE SHOP, OPEN 24/7

Just type in wurth.fr and you're connected.

ORSY

An organisation system and a complete solution suited to your stock

ORSY is a storage module system that allows the optimal management and organisation of your product stocks and offers perfect oversight.

The ORSY installation system is modular and can be customised according to the space available, the product references used and the quantities required. Designed exclusively to accommodate Würth products, ORSY is the stock management solution!



ORSYscan

A fast restocking system

ORSYscan is a system that allows you to restock easily and faster.

Just scan the barcode of the article stocked in your ORSY storage system, your ORSY packaging or in a barcode catalogue. With its direct link to the online catalogue, the scanner transmits your order to Würth automatically.





KING TONY

Enjoy your work

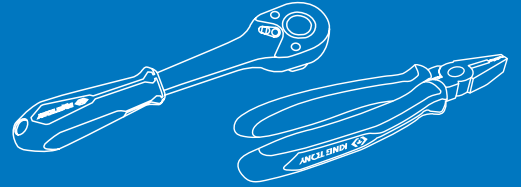

ALL THE PROFESSIONAL TOOLS YOU NEED

7000 + REFERENCES

PARTNERS WITH MANITOU SINCE 2005

THE SELECTION IN **MANITOU** HANDLING YOUR WORLD COLOURS by KING TONY



MANITOU METAL TOOL BOX 5 COMPARTMENTS

Folding handles. Reinforced opening and body. 5 compartments on 3 levels. Space for a padlock.
Total dimensions: 470x220x260mm



MANITOU TOOL TROLLEY 7-DRAWER

Key central locking. Drawers mounted on smooth ball bearing slides. 4 Wheels (including 2 guide wheels with ball bearing brakes). 1mm sheet metal monobloc body and drawers. Base and top 1.2mm manufactured sheet metal.

Total size including wheels : 670x460x943mm



Innovative light performance

Innovation and experience

The Oval 100 LED worklight can be used in many applications.

Thanks to its powerful light output, the Oval 100 LED can replace standard halogen worklights and does so, with a power consumption of just 25 watts.

For more information:

www.manitou.com

www.hella.com/agiculture



For more information:
www.manitou.com
www.hella.com/agiculture

Technology with Vision



LIGHTING MADE FOR WORKING PEOPLE



Innovation and experience

Manitou and HELLA are among the leading suppliers in the agricultural and farming industries. Benefit from our longtime experience and innovative technologies. Step into the future with innovative products from Manitou and HELLA.



For more information:
www.manitou.com
www.hella.com/agiculture

Technology with Vision



Your dealer :



 **MANITOU**
HANDLING YOUR WORLD

B.P. 249 - 430 rue de l'Aubinière - 44158 Ancenis Cedex - France
Tel. : 00 33 (0)2 40 09 10 11 - Fax: 00 33 (0)2 40 83 36 88
www.manitou.com

CE This brochure describes versions and configuration options for Manitou products which may be fitted with different equipment. The equipment described in this brochure may be standard, optional or not available depending on version. Manitou reserves the right to change the specifications shown and described at any time and without prior warning. The manufacturer is not liable for the specifications given. For more information, contact your Manitou dealer. Non-contractual document. Product descriptions may differ from actual products. List of specifications is not comprehensive. The logos and visual identity of the company are the property of Manitou and may not be used without authorisation. All rights reserved. The photos and diagrams contained in this brochure are provided for information only.

MANITOU BF SA - Limited company with board of directors - Share capital: 39,547,824 euros - 857 802 508 RCS Nantes